

PLUS



PLUS 3



PLUS 5



PLUS 7



PLUS 9



PLUS 18



Pompe centrifughe multistadio orizzontali. Adatte alla movimentazione di liquidi non carichi; sistemi di pressurizzazione; irrigazione; acque potabili o con glicole in soluzione; trattamento acque; industria alimentare; riscaldamento e condizionamento; sistemi di lavaggio.

Stainless steel multistage horizontal pumps. Pumping of clean non-loaded fluids; pressurizing system; irrigation; drinking and glycol water; water treatment; heating and air conditioning; washing system.

Bombas centrífugas multietapas horizontales. Bombeo de líquidos químicamente y mecánicamente no agresivos; sistemas de presurización; riegos; agua potable o con glycol; tratamientos del agua; industria alimenticia; calefacción y refrigeración; sistemas de lavado.

Pompes centrifuges multicellulaires horizontales. Pompage d'eaux propres non chargées; groupes de surpression; irrigation; eau potable ou solution de glycol; traitement des eaux; industrie alimentaire; chauffage et climatisation; stations de lavage auto.

CARATTERISTICHE COSTRUTTIVE / CONSTRUCTION FEATURES CARACTERÍSTICAS CONSTRUCTIVAS / CARACTÉRISTIQUES D'EXÉCUTION

Corpo pompa Pump body	acciaio cromo-nickel AISI 304 stainless steel AISI 304
Cuerpo bomba Corps de pompe	acero cromo-níquel AISI 304 acier chrome-nickel AISI 304
Supporto motore Motor bracket	alluminio aluminium
Soporte motor Support moteur	aluminio aluminium
Giranti, diffusori Impellers, diffusers Rodetes, difusores Turbines, diffuseurs	Noryl®
Tenuta meccanica	ceramica-grafite ≤ 6 giranti grafite-carburo di silicio ≥ 7 giranti
Mechanical seal	ceramic-graphite ≤ 6 impellers graphite-silicon carbide ≥ 7 impellers
Sello mecánico	cerámica-grafito ≤ 6 rodetes grafito-carburo de silicio ≥ 7 rodetes
Garniture mécanique	céramique-graphite ≤ 6 turbines graphite-carbure de silicium ≥ 7 turbines
Albero motore Motor shaft	acciaio cromo-nickel AISI 303 stainless steel AISI 303
Eje motor Arbre moteur	acero cromo-níquel AISI 303 acier chrome-nickel AISI 303
Temperatura del liquido Liquid temperature Temperatura del líquido Température du liquide	-5 ÷ +35 °C
Pressione di esercizio Operating pressure Presión de trabajo Pression de fonctionnement	max 8,5 bar
MOTORE / MOTOR / MOTOR / MOTEUR	
Motore 2 poli a induzione	3~ 230/400V-50Hz
2 pole induction motor	1~ 230V-50Hz
Motor de 2 polos a inducción	(con termoprotettore fino a 1,85kW with thermal protection up to 1,85 kW con protección térmica hasta 1,85 kW avec protection thermique jusqu'à 1,85 kW)
Moteur à induction à 2 pôles	
Classe di isolamento Insulation class Clase de aislamiento Classe d'isolation	F
Grado di protezione Protection degree Grado de protección Protection	IP44

P 3 - 120/6 T

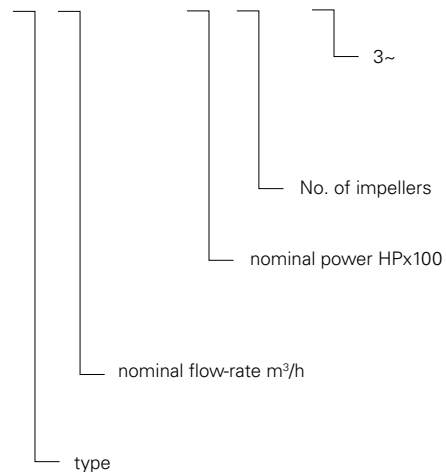

3

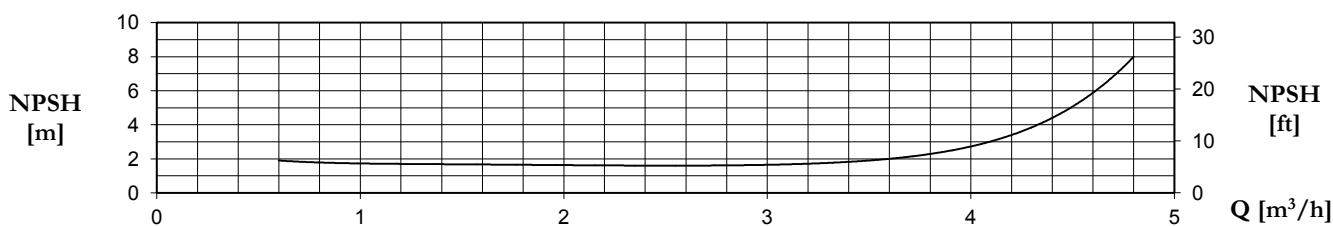
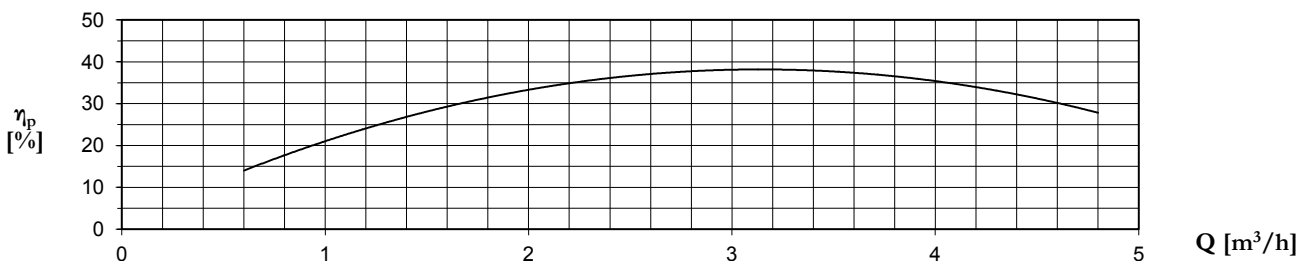
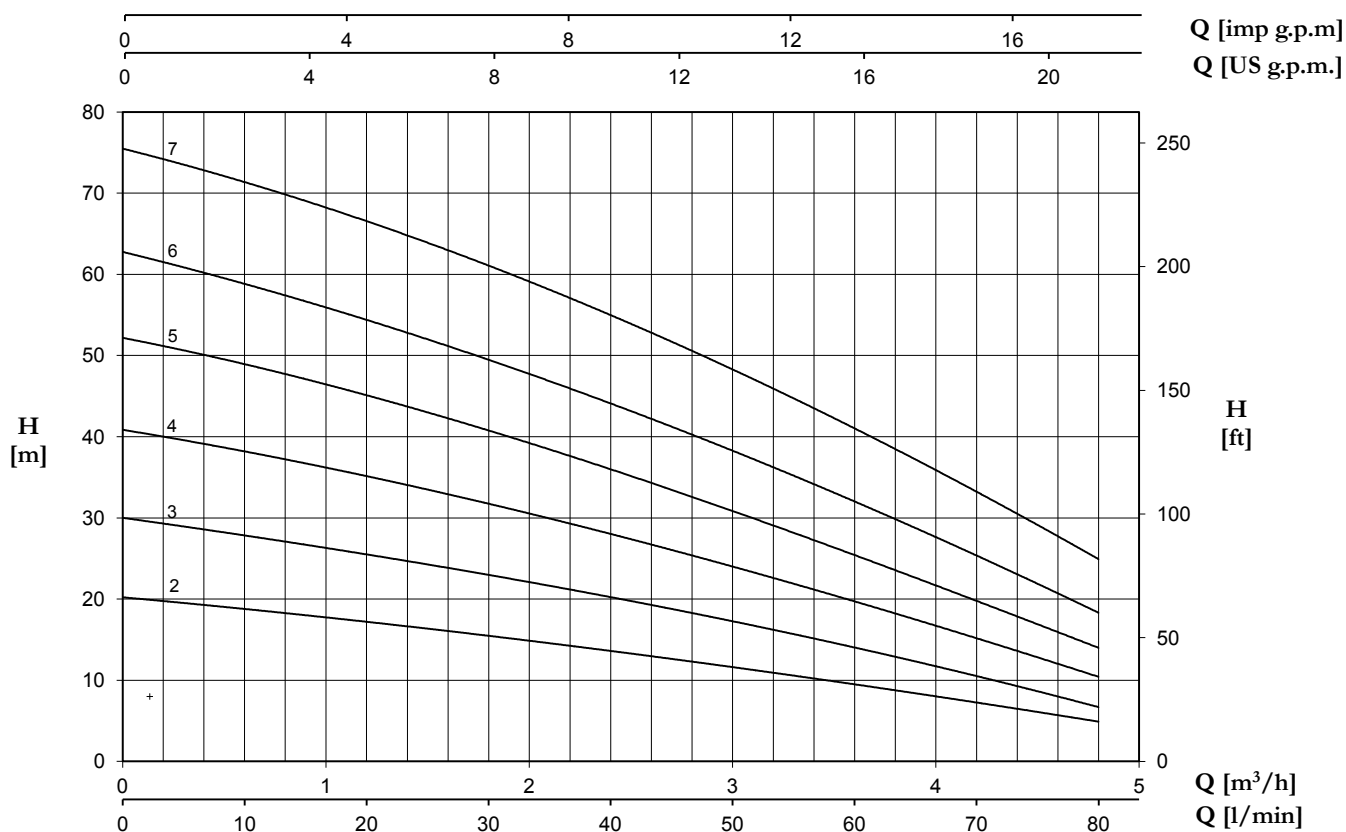

TYPE		P2		P1 (kW)		AMPERE		Q (m³/h - l/min)						
1~	3~	(HP)	(kW)	1~	3~	1~	3~	0	0,6	1,2	1,8	2,4	3,6	4,8
						50 Hz	50 Hz	0	10	20	30	40	60	80
								H (m)						
P 3-50/2	P 3-50/2T	0,5	0,37	0,45	0,46	2	0,9	20,2	18,8	17,3	15,3	13,7	9,5	4,9
P 3-70/3	P 3-70/3T	0,7	0,51	0,65	0,63	2,9	1,2	30	27,9	25,4	23	20,3	14	6,7
P 3-90/4	P 3-90/4T	0,9	0,66	0,9	0,88	4	1,8	40,8	38,3	35,1	31,8	27,9	19,8	10,4
P 3-100/5	P 3-100/5T	1	0,75	1,06	1,01	4,8	1,9	52,2	48,9	45,1	40,8	36	25,4	14
P 3-120/6	P 3-120/6T	1,2	0,9	1,23	1,23	5,6	2,6	62,8	58,7	54,5	49,6	43,9	32,1	18,3
P 3-150/7	P 3-150/7T	1,5	1,1	1,54	1,45	7,1	2,9	75,5	71,3	66,6	61,2	54,8	41,1	24,9

5

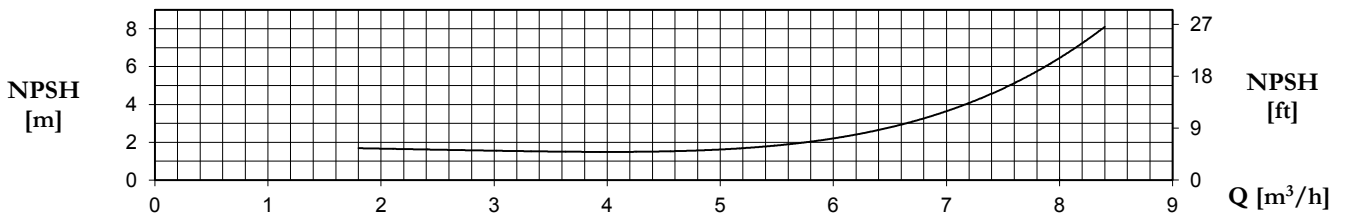
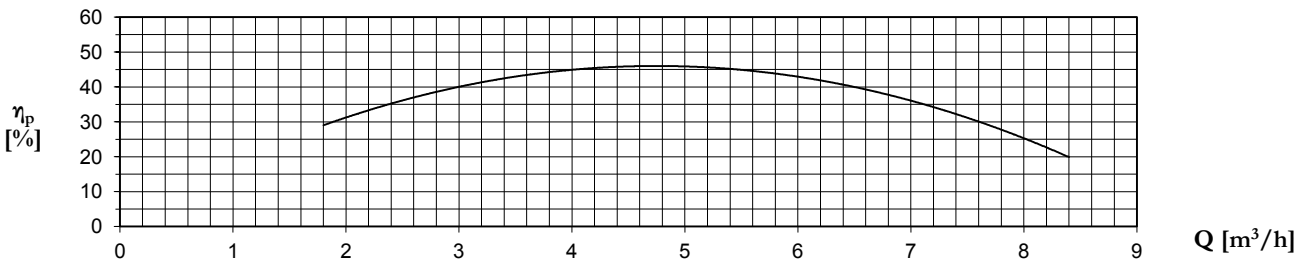
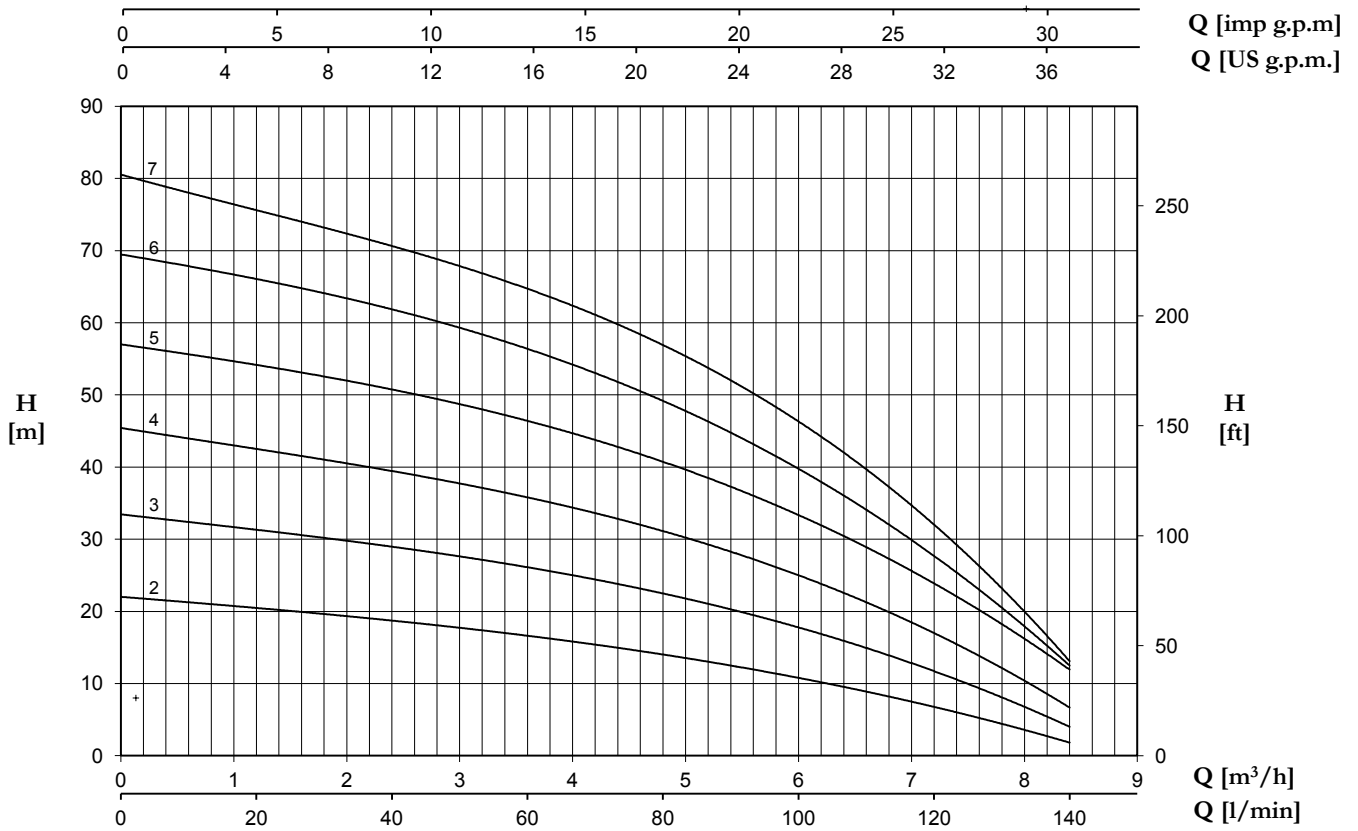

TYPE		P2		P1 (kW)		AMPERE		Q (m³/h - l/min)							
1~	3~					1~	3~	0	1,8	2,4	3,6	4,8	6	7,2	8,4
		(HP)	(kW)	1~	3~	1x230 V 50 Hz	3x400 V 50 Hz	H (m)							
P 5-70/2	P 5-70/2T	0,7	0,51	0,61	0,58	2,7	1,1	22	19,7	18,7	16,6	14	10,8	6,8	1,8
P 5-80/3	P 5-80/3T	0,8	0,6	0,86	0,79	3,9	1,5	33,4	30,3	29	26	22,5	17,6	12	3,9
P 5-120/4	P 5-120/4T	1,2	0,9	1,13	1,13	5,2	2,5	45,3	41,3	39,6	35,6	30,8	24,9	17,6	6,4
P 5-150/5	P 5-150/5T	1,5	1,1	1,47	1,39	6,8	2,8	56,8	53	51	46,1	40,1	33,3	24,8	11,5
P 5-180/6	P 5-180/6T	1,8	1,3	1,7	1,62	7,7	3	69,3	64,4	62	55,6	48,2	39,6	28,8	12
P 5-200/7	P 5-200/7T	2	1,5	2	1,86	9	3,4	80,3	73,6	71	64,5	56,1	46	33,4	12,5

7

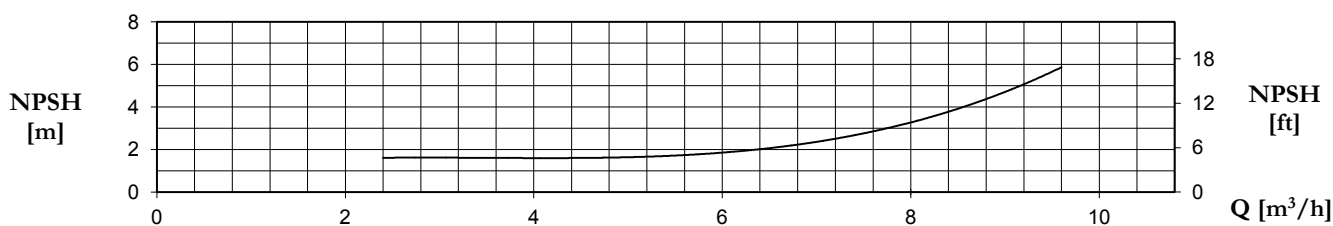
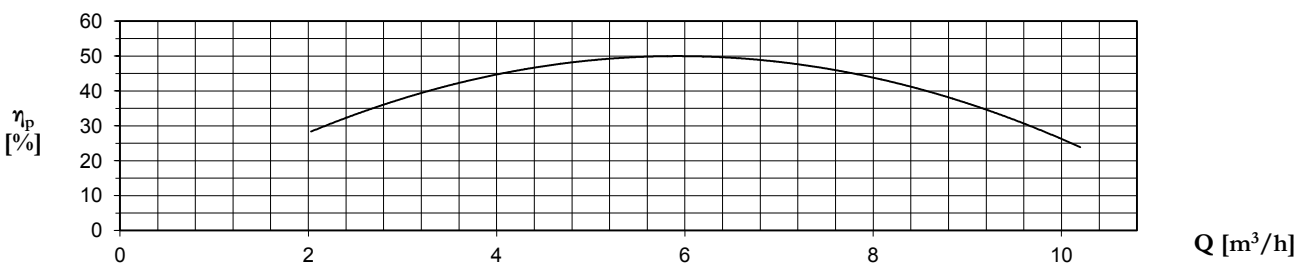
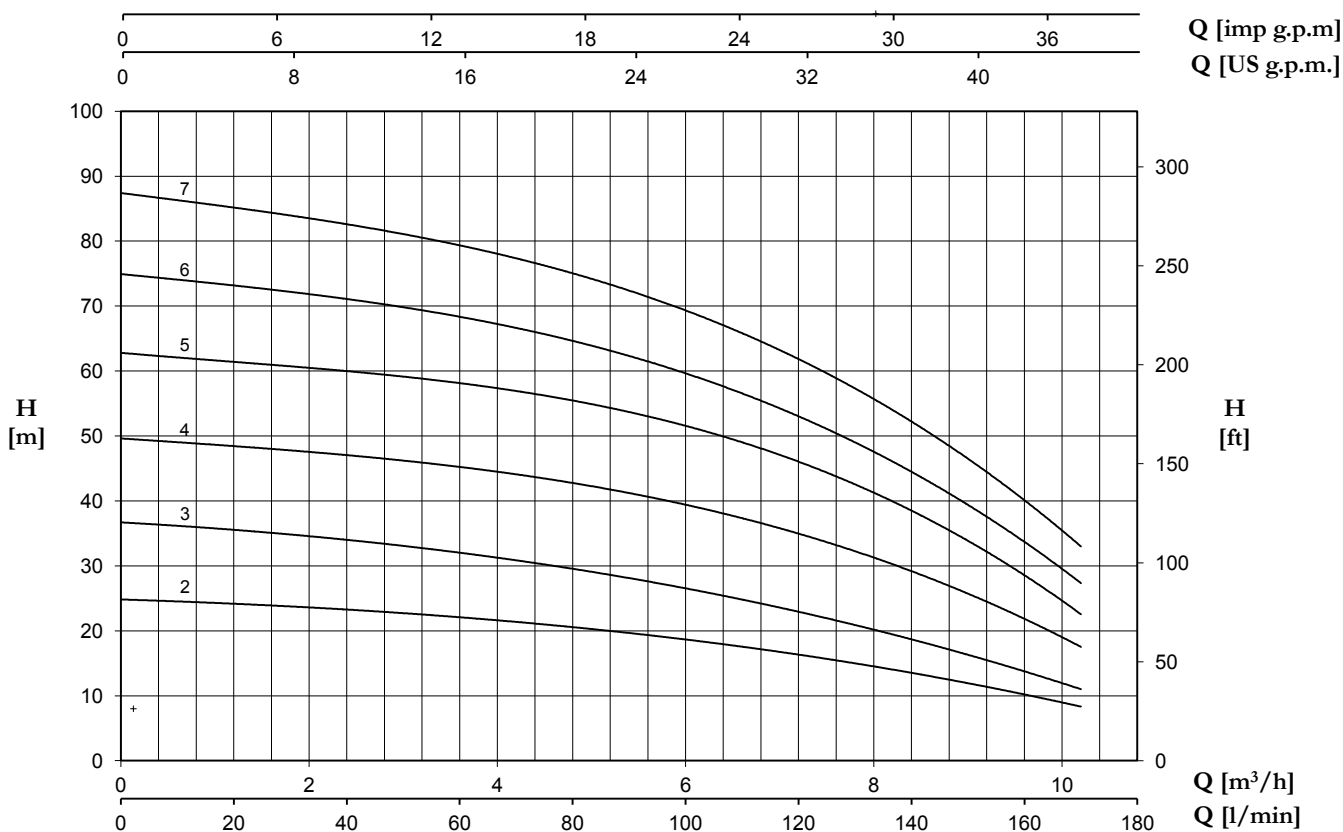

TYPE		P2		P1 (kW)		AMPERE		Q (m³/h - l/min)								
1~	3~					1~	3~	0	2,4	3,6	4,8	6	7,2	8,4	9,6	10,2
		(HP)	(kW)	1~	3~	1x230 V 50 Hz	3x400 V 50 Hz	H (m)								
P 7-100/2	P 7-100/2T	1	0,75	0,97	0,9	4,4	1,7	24,8	23,4	22	20,5	18,7	16,3	13,6	10,2	8,3
P 7-120/3	P 7-120/3T	1,2	0,9	1,32	1,3	5,9	2,6	36,7	34	32	29,6	26,5	23	18,6	13,8	11
P 7-180/4	P 7-180/4T	1,8	1,3	1,83	1,71	8,3	3,2	49,5	47,4	45,3	42,5	39,2	34,8	29,4	22,6	16,9
P 7-250/5	P 7-250/5T	2,5	1,85	2,39	2,15	10,9	4,2	62,6	60,6	58,2	55,1	51,1	45,8	39	29,8	21,5
P 7-300/6	P 7-300/6T	3	2,2	2,68	2,63	12,2	5	74,8	71,5	68,3	64,5	59,3	53	44,6	34,5	26,7
-	P 7-350/7T	3,5	2,57	-	3,04	-	5,5	87,2	83,3	79,3	74,6	68,9	61,9	52,5	41	32,2

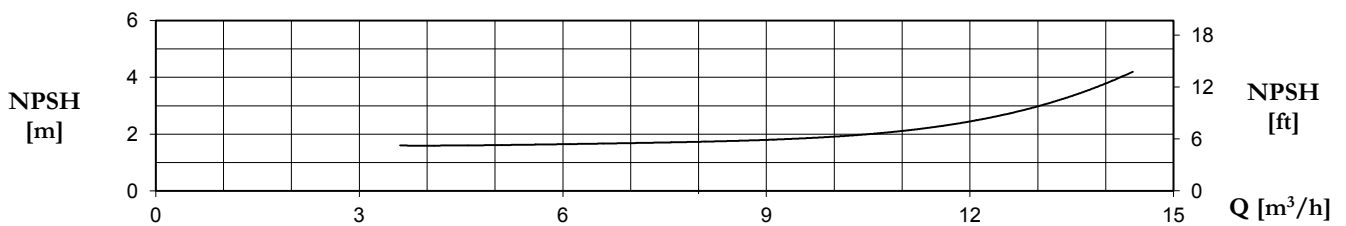
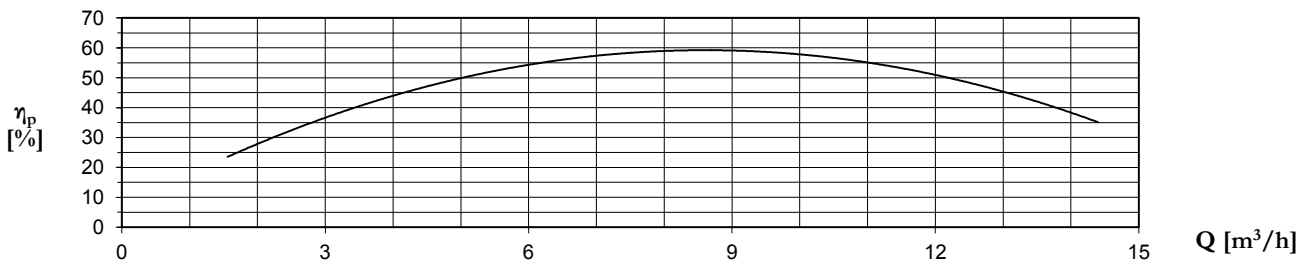
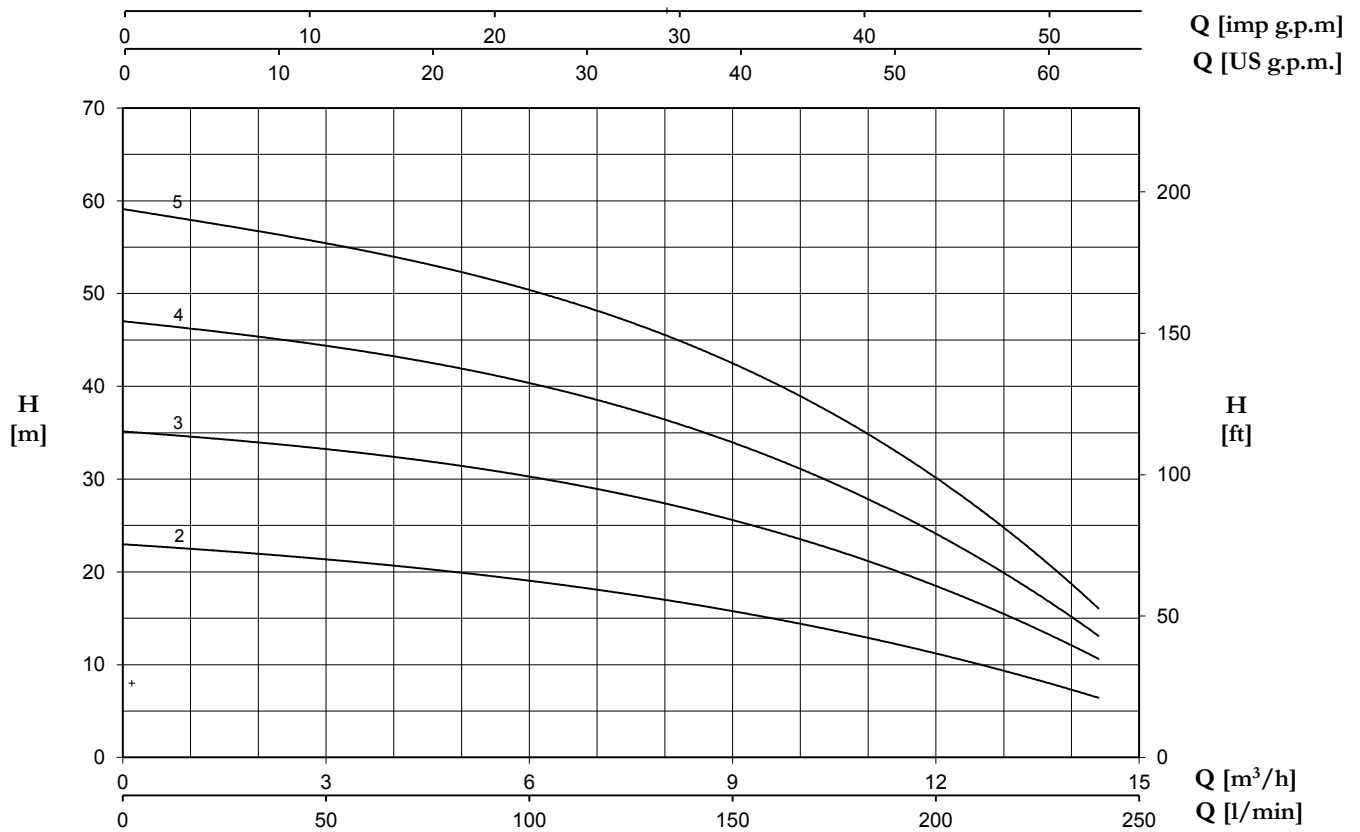

TYPE		P2		P1 (kW)		AMPERE		Q (m³/h - l/min)										
1~	3~					1~	3~	0	3,6	4,8	6	7,2	8,4	9,6	10,8	12	13,2	14,4
						50 Hz		0	60	80	100	120	140	160	180	200	220	240
						1x230 V	3x400 V	H (m)										
		(HP)	(kW)	1~	3~	50 Hz	50 Hz	23	20,9	20	19,1	17,9	16,6	15	13,2	11,1	8,9	6,5
P 9-100/2	P 9-100/2T	1	0,75	0,98	0,92	4,4	1,7	23	20,9	20	19,1	17,9	16,6	15	13,2	11,1	8,9	6,5
P 9-150/3	P 9-150/3T	1,5	1,1	1,43	1,38	6,7	2,8	35,2	32,6	31,5	30,3	28,8	26,9	24,5	21,5	18,3	14,7	10,8
P 9-200/4	P 9-200/4T	2	1,5	1,88	1,77	8,4	3,3	47,1	43,5	42	40,5	38,3	35,7	32,4	28,4	23,8	18,9	13,3
P 9-250/5	P 9-250/5T	2,5	1,85	2,32	2,18	10,6	4,3	59,2	54,4	52,4	50,4	47,9	44,8	40,5	35,5	29,8	23,5	16,3

18

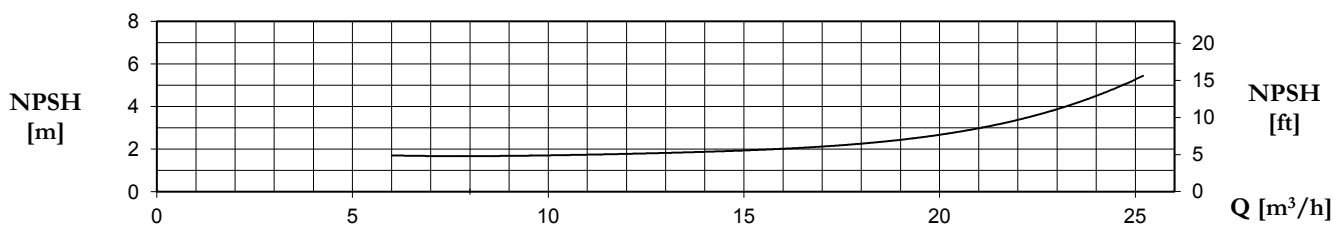
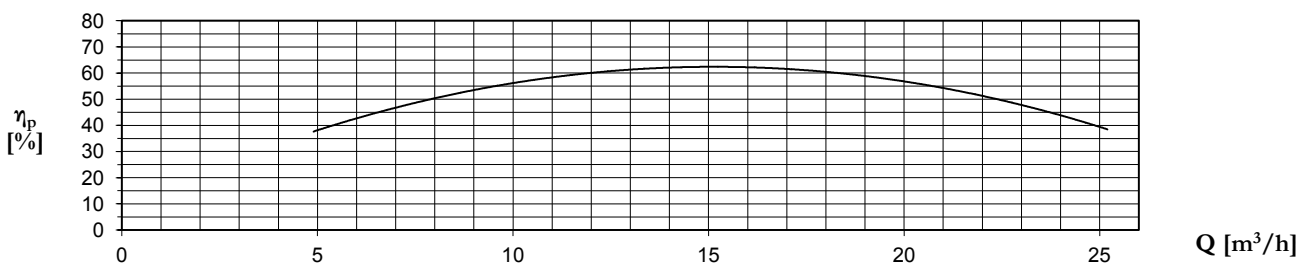
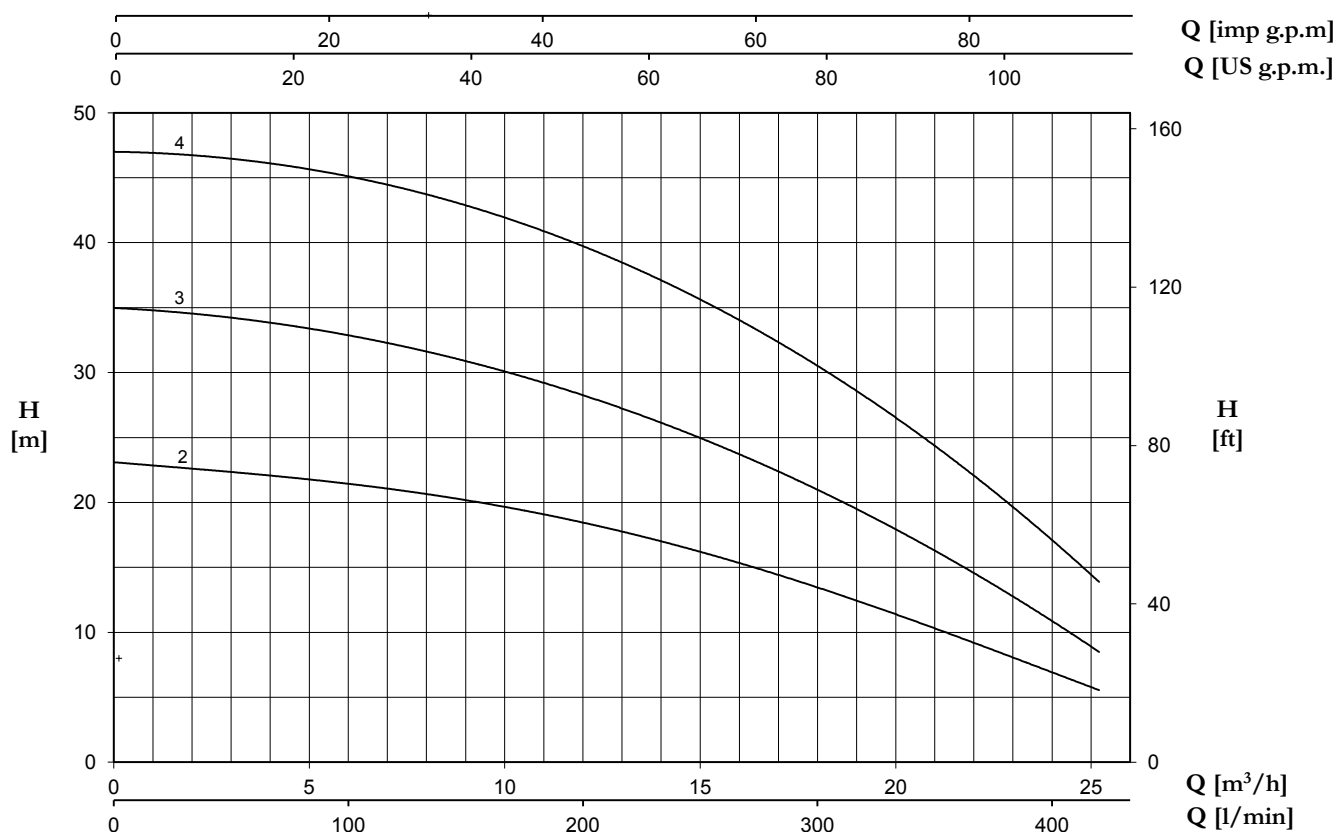

TYPE	P2		P1 (kW)	A	Q (m³/h - l/min)																	
					3~																	
					H (m)																	
3~	(HP)	(kW)	3~	3~	0	6	7,2	8,4	9,6	10,8	12	13,2	14,4	15,6	16,8	18	19,2	20,4	21,6	22,8	24	25,2
				3x400 V 50 Hz	0	100	120	140	160	180	200	220	240	260	280	300	320	340	360	380	400	420
P 18-180/2T	1,8	1,3	1,52	3	23,1	21,4	21	20,5	19,9	19,2	18,4	17,6	16,7	15,7	14,7	13,5	12,1	10,9	9,7	8,3	7	5,5
P 18-250/3T	2,5	1,85	2,19	4,3	35	32,7	32,2	31,4	30,5	29,5	28,3	26,7	25,5	24,3	22,8	21,2	19,3	17,3	15,1	12,9	10,8	8,7
P 18-400/4T	4	3	2,99	5,5	47,2	44,6	44,1	43,3	42,4	41,2	40	38,5	36,7	34,9	32,9	30,5	27,9	25,3	22,7	20	17,1	14,3

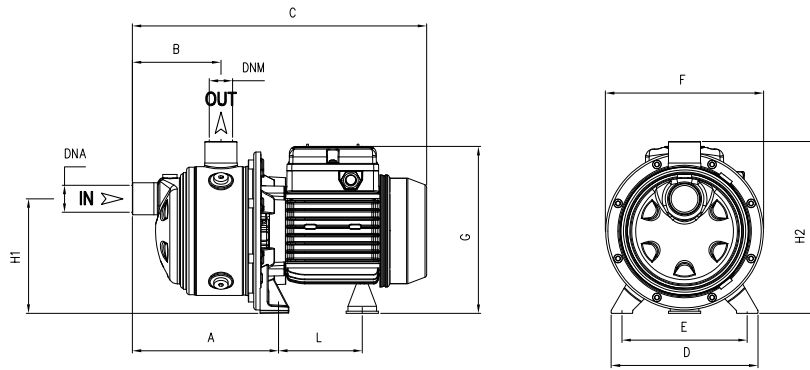

TYPE	DIMENSIONS (mm)										Kg	DNA	DNM
	A	B	C	D	E	F	G	L	H1	H2			
P 3-50/2	166.8	103	333	164	140	178	190	93.7	128	192	6,5	1" G	1" G
P 3-70/3	166.8	103	333	164	140	178	190	93.7	128	192	7		
P 3-90/4	190.8	127	357	164	140	178	190	93.7	128	192	8,5		
P 3-100/5	214.8	151	404	164	140	178	203	104.7	128	192	10,5		
P 3-120/6	238.8	175	428	164	140	178	203	104.7	128	192	11,5		
P 3-150/7	262,8	199	483	164	140	201	211	128.2	134	198	14,5		
P 5-70/2	166.8	103	333	164	140	178	195	93.7	128	192	7		
P 5-80/3	166.8	103	357	164	140	178	203	93.7	128	192	9,5		
P 5-120/4	190.8	127	380	164	140	178	203	104.7	128	192	11		
P 5-150/5	214.8	151	436	164	140	201	211	128.2	134	198	13,5		
P 5-180/6	238.8	175	459	164	140	201	211	128.2	134	198	15		
P 5-200/7	262.8	199	483	164	140	201	211	128.2	134	198	16		

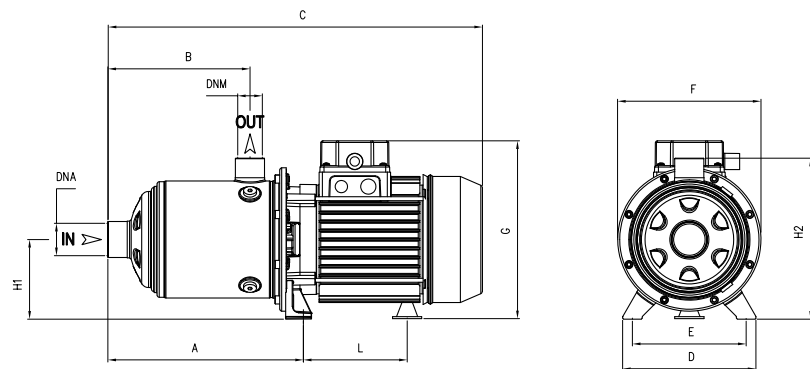

TYPE	DIMENSIONS (mm)										Kg	DNA	DNM
	A	B	C	D	E	F	G	L	H1	H2			
P 7-100/2	166.8	103	356	164	140	178	203	104.7	92	192	10	1" 1/4 G	1" G
P 7-120/3	166.8	103	356	164	140	178	203	104.7	92	192	10,5		
P 7-180/4	190.8	127	411	164	140	201	211	128.2	98	198	14		
P 7-250/5	214.8	151	436	164	140	201	211	128.2	98	198	16		
P 7-300/6	238.8	175	M 503 T 459	164	140	201	M 229 T 211	M 148.2 T 128.2	M 103 T 98	M 203 T 198	M 18 T 16		
P 7-350/7	262.8	199	527	164	140	201	229	148.2	103	203	18		
P 9-100/2	185.8	118	375	164	140	178	203	104,7	98	192	10	1" 1/2 G	1" 1/4 G
P 9-150/3	185.8	118	375	164	140	201	211	128.2	98	198	13		
P 9-200/4	215.8	148	436	164	140	201	211	128.2	98	198	15		
P 9-250/5	245.8	178	464	164	140	201	211	128.2	98	198	16		
P 18-180/2T	201	141	432	164	140	201	211	128.2	98	198	13	2" G	1" 1/2 G
P 18-250/3T	238.5	141	432	164	140	201	211	128.2	98	198	15		
P 18-400/4T	276	178.5	514	164	140	201	229	148,2	103	203	20,5		

TYPE	TRUCK		CONTAINER	
	PALLET (cm)	N° pumps	PALLET (cm)	N° pumps
P 3-50/2-90/4	80X120X150	84	80X120X175	96
P 3-100/5-120/6	85X110X160	70	85X110X185	80
P 3-150/7	80X120X150	42	80X120X175	49
P 5-70/2	80X120X150	84	80X120X175	96
P 5-80/3-120/4	85X110X160	70	85X110X185	80
P 5-150/5	90X110X150	54	90X110X170	63
P 5-180/6-200/7	80X120X150	42	80X120X175	49
P 7-100/2-120/3	85X110X160	70	85X110X185	80
P 7-180/4-250/5	90X110X150	54	90X110X170	63
P 7-300/6T	80X120X150	42	80X120X175	49
P 7-300/6 M-350/7T	80X120X145	35	80X120X170	42
P 9-100/2	85X110X160	70	85X110X185	80
P 9-150/3-200/4	90X110X150	54	90X110X170	63
P 9-250/5	80X120X150	42	80X120X175	49
P 18-180/2-250/3	90X110X150	54	90X110X170	63
P 18-400/4	80X120X145	35	80X120X170	42