

MA/MAT EN 733 ~ 2900 r.p.m.

MAX EN 733 ~ 2900 r.p.m.

4MA/4MAT EN 733 ~ 1450 r.p.m.

4MAX EN 733 ~ 1450 r.p.m.



**MA/MAT
4MA/4MAT**



**MAX
4MAX**

Pompe centrifughe ad asse libero costruite secondo le norme EN 733; trovano vasto utilizzo nell'alimentazione idrica, negli impianti di pressurizzazione e antincendio; come standard vengono fornite di controflangia.

Bare shaft centrifugal pumps constructed to EN 733 standards; widely used in water supplies, pressurisation and fire-fighting systems, standard supply with counter-flange.

Bombas centrífugas de eje libre fabricadas según las normas EN 733; se utilizan en gran parte en la alimentación hídrica, en las instalaciones de presurización y antiincendio; según el estándar se suministran con contrabrida.

Pompes centrifuges à axe libre, fabriquées conformément aux normes EN 733. Elles trouvent une ample utilisation dans l'approvisionnement d'eau, dans les installations de pressurisation et anti-incendie; fournies de série avec contre-bride.

**CARATTERISTICHE COSTRUTTIVE / CONSTRUCTION FEATURES
CARACTERÍSTICAS CONSTRUCTIVAS / CARACTÉRISTIQUES D'EXÉCUTION**

Corpo pompa	ghisa (MA/MAT) - acciaio inossidabile AISI 316 (MAX)
Pump body	cast iron (MA/MAT) - stainless steel AISI 316 (MAX)
Cuerpo bomba	fundición (MA/MAT) - acero inoxidable AISI 316 (MAX)
Corps de pompe	fonte (MA/MAT) - acier inox AISI 316 (MAX)
Supporto motore	ghisa
Motor bracket	cast iron
Soporte motor	fundición
Support moteur	fonte
Girante	ghisa, bronzo, acciaio (MA/MAT) - acciaio (MAX)
Impeller	cast iron, bronze, steel (MA/MAT) - steel (MAX)
Rodete	fundición, bronce, acero (MA/MAT) - acero (MAX)
Turbine	fonte, bronze, acier (MA/MAT) - acier (MAX)
Tenuta	meccanica ceramica-grafite (MA/MAX) o a baderna cotone impregnato grafite (MAT)
Seal	mechanical ceramic-graphite (MA/MAX) or gland packing graphite impregnated (MAT)
Sello	mecánico cerámica-grafito (MA/MAX) or a trenza algodón impregnado de grafito (MAT)
Garniture	mécanique céramique-graphite (MA/MAX) ou à baderne coton imprégné graphite (MAT)
Sporgenza albero pompa	acciaio AISI 316
Pump shaft end	stainless steel AISI 316
Bomba eje	acero AISI 316
Pompe arbre	acier AISI 316
Temperatura del liquido	
Liquid temperature	-10 ÷ +90 °C
Temperatura del líquido	
Température du liquide	
Pressione di esercizio	
Operating pressure	max 10 bar
Presión de trabajo	max 14 bar (... -315 ~ 2900 r.p.m.)
Pression de fonctionnement	

MOTORE / MOTOR / MOTOR / MOTEUR

Disponibile con motore classe di efficienza IE3 o standard

Available with IE3 efficiency class motor or standard

Disponibile con motor class IE3 o estandar

Disponibile avec moteur classe IE3 ou standard

MA/MAT - MAX EN 733 ~ 2900 r.p.m.
4MA/4MAT - 4MAX EN 733 ~ 1450 r.p.m.

VARIANTI COSTRUTTIVE /VERSIONS
VARIABLES COSTRUTTIVAS / VARIANTES DE CONSTRUCTIONS

MA

- T** tenuta a baderna / gland packing seal
 sello a trenza algodón / garniture à baderne
 (except MA65/80-315)
 - X** idraulica in acciaio / stainless steel hydraulic part
 hidraulica en acero / hydraulique en acier
 (except MA65/80-315)
- type

4MA

- T** tenuta a baderna / gland packing seal
 sello a trenza algodón / garniture à baderne
 - X** idraulica in acciaio / stainless steel hydraulic part
 hidraulica en acero / hydraulique en acier
- type

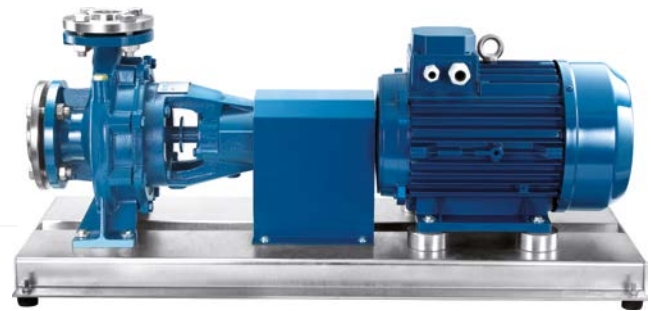

MA/MAT
4MA/4MAT

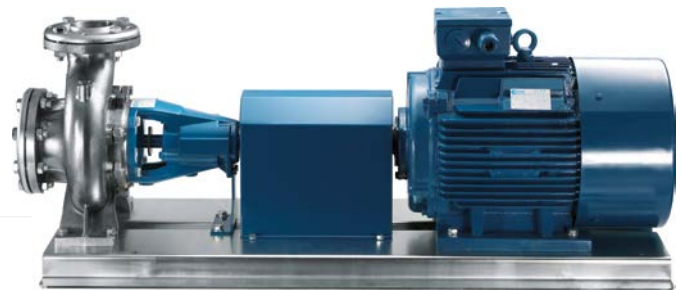

MAX
4MAX

MA/MAX
4MA/4MAX
 tenuta meccanica
 mechanical seal
 sello mecánico
 garniture mécanique



MAT
4MAT
 tenuta a baderna
 gland packing seal
 sello a trenza algodón
 garniture à baderne

MA/MAT - MAX EN 733 ~ 2900 r.p.m.

TYPE	Nominal Power (kW)	Motor Size	Q (m³/h - l/min)												
			0	4,5	6	7,5	9	12	15	18	21	24	27	30	33
			0	75	100	125	150	200	250	300	350	400	450	500	550
H (m)															
pump input power (kW)															
32-160C	1,5	90S	24,4	24,3	24,0	23,5	23,0	21,8	20,0	17,5	14,8				
	2,2	90L	0,73	0,98	1,07	1,16	1,24	1,39	1,52	1,62	1,71				
32-160B	2,2	90L	28,1	28,2	27,9	27,5	27,0	25,9	24,4	22,2	19,5	16,6			
			0,97	1,25	1,36	1,46	1,56	1,75	1,92	2,06	2,17	2,28			
32-160A	3	100L	36,8	36,6	36,4	36,0	35,6	34,5	33,2	31,5	29,1	26,0	22,8		
32-200C	4	112M	40,1		39,7	39,6	39,3	38,3	36,9	35,2	33,0	30,4	27,6		
			1,24	1,61	1,74	1,88	2,01	2,27	2,50	2,70	2,88	3,03	3,16		
32-200B	5,5	132S	50,1		50,2	50,1	49,9	49,3	48,0	46,4	44,5	42,4	39,8	37,2	
			2,34		3,31	3,53	3,75	4,14	4,50	4,84	5,15	5,43	5,69	5,92	
32-200A	7,5	132S	58,6		59,0	58,9	58,8	58,2	57,1	55,5	53,4	51,1	48,4	45,6	42,5
			3,03		3,96	4,19	4,43	4,90	5,36	5,76	6,11	6,52	6,92	7,22	7,45
32-250C	11	160M	70,0			68,5	68,0	67,0	65,5	63,5	61	58	50	36,5	
			4,89			6,15	6,48	7,11	7,74	8,19	8,54	8,89	9,24	9,63	
32-250B	11	160M	82,0			81,0	80,5	79,5	78,5	77,0	74,5	71,9	65	52,5	
	15	160M	6,45			8,02	8,35	9,00	9,56	10,1	10,5	11,2	11,8	12,1	
32-250A	15	160M	93,0			92,5	92,0	91,5	90,5	89,5	87,5	85	78,5	66	
			7,85			9,30	9,88	10,7	11,4	12,2	12,9	13,6	14,3	14,9	
40-125C	1,5	90S	18,9				19,0	18,8	18,3	17,7	16,9	15,9	14,7	13,2	11,6
			0,69				1,05	1,18	1,30	1,40	1,48	1,55	1,60	1,63	1,65
40-125B	2,2	90L	22,5				22,9	22,8	22,5	21,9	21,2	20,3	19,2	18,0	16,7
			0,86				1,28	1,45	1,60	1,74	1,86	1,96	2,04	2,10	2,15
40-125A	3	100L	26,2				26,6	26,5	26,3	25,9	25,2	24,4	23,4	22,2	20,9
			1,11				1,60	1,79	1,98	2,15	2,30	2,43	2,55	2,66	2,75
40-160B	3	100L	30,0				30,1	30,0	29,6	29,0	28,2	27,1	25,9	24,4	22,8
	4	112M	1,39				2,00	2,20	2,38	2,57	2,75	2,91	3,04	3,16	3,26
40-160A	4	112M	35,4				35,6	35,5	35,3	35,0	34,2	33,2	32,0	30,6	29,0
	5,5	132S	1,64				2,36	2,55	2,78	3,00	3,21	3,40	3,56	3,72	3,86
40-200B	5,5	132S	44,7				44,9	44,8	44,6	44,0	42,9	41,6	40,0	38,1	36,1
			2,30				3,30	3,60	3,80	4,20	4,60	4,60	5,00	5,30	5,40
40-200A	7,5	132S	57,7				57,7	57,5	57,1	56,3	55,4	54,1	52,5	50,5	48,5
			3,20				4,30	4,60	5,20	5,60	6,10	6,40	6,70	7,10	7,40
40-250C	11	160M	63,0				62,6	62,4	61,9	61,3	60,5	59,7	58,6	57,1	55,0
			4,40				5,60	6,08	6,61	7,13	7,63	8,10	8,57	9,04	9,45
40-250B	11	160M	70,8				71,3	71,2	71,0	70,5	69,8	68,4	66,6	65,4	63,8
	15	160M	5,16				6,65	7,22	7,76	8,28	8,80	9,33	9,86	10,35	10,82
40-250A	15	160M	86,1				86,3	86,5	86,4	86,0	85,6	85,0	84,1	82,9	81,3
	18,5	160L	6,70				8,24	8,89	9,58	10,29	10,97	11,65	12,31	12,95	13,55
40-250BM	18,5	160L	93,1				93,8	94,2	94,2	93,8	93,4	92,9	92,2	91,3	90,2
			6,81				8,68	9,59	10,35	11,05	11,73	12,40	13,06	13,74	14,40
40-250AM	22	180M	101,6				101,9	101,6	101,4	101,2	101,0	100,7	100,3	99,7	98,9
			8,99				10,26	10,99	11,69	12,40	13,13	13,84	14,57	15,33	16,11
50-125B	3	100L	19,9					20,2	20,2	20,1	20,0	19,8	19,3	19,1	18,7
	4	112M	1,22					1,77	1,94	2,11	2,22	2,33	2,44	2,55	2,65
50-125A	4	112M	24,5						25,0	24,9	24,8	24,6	24,4	24,2	23,8
	5,5	132S	1,78						2,54	2,70	2,85	3,01	3,17	3,33	3,42
50-160B	5,5	132S	31,1								32,1	32,0	31,7	31,4	31,0
			2,10								3,60	3,80	4,00	4,20	4,40
50-160A	7,5	132S	36,7								37,9	37,8	37,7	37,4	37,1
			2,60								4,20	4,50	4,90	5,10	5,40
50-200C	11	160M	46,0									45,6	45,1	44,5	43,7
			3,25									6,08	6,30	6,53	6,76
50-200B	11	160M	50,8									51,0	50,5	50,0	49,3
			3,38									6,68	7,53	7,80	8,20
50-200A	15	160M	58,0									58,3	58,0	57,5	57,0
			4,63									7,89	8,28	8,67	9,08
50-250C	15	160M	71,5										70,8	70,3	69,7
	18,5	160L	6,74										11,32	11,90	12,50
50-250B	18,5	160L	78,0										78,0	77,4	76,8
	22	180M	6,87										11,98	12,70	13,31
50-250A	22	180M	90,0										89,5	88,8	88,3
	30	200L	10,10										15,63	16,30	16,98
50-315DN No EN 733; only MA version	37	200L	87,8												
			11,19												
50-315CN No EN 733; only MA version	45	225M	101,8												
			13,32												
50-315BN No EN 733; only MA version	55	250M	122,3												
			17,44												
50-315AN No EN 733; only MA version	75	280S	146,1												
			22,75												

MA/MAT - MAX EN 733 ~ 2900 r.p.m.

Q (m³/h - l/min)														
36	39	42	48	54	60	66	72	78	84	96	108	120	132	144
600	650	700	800	900	1000	1100	1200	1300	1400	1600	1800	2000	2200	2400
H (m) pump input power (kW)														
9,9														
1,66														
15,2	13,4													
2,19	2,22													
19,4	17,8	16,0												
2,82	2,87	2,92												
21,0	19,1													
3,35	3,41													
27,3	25,4	23,5												
3,99	4,08	4,17												
33,6	30,8	27,9												
5,60	5,70	6,00												
45,9	43,3	40,3												
7,60	7,90	8,00												
52,4	49,6													
9,83	10,22													
61,2	58,5	55,6												
11,25	11,69	12,11												
79,4	77,0	74,3	67,9											
14,13	14,74	15,32	16,27											
88,8	87,3	85,6	81,4	75,1										
15,03	15,63	16,20	17,29	18,37										
97,8	96,3	94,6	91,2	87,0	80,6									
16,85	17,56	18,26	19,57	20,75	21,89									
18,3	17,8	17,4	16,4	15,3	14,0	12,7	11,2							
2,76	2,87	2,98	3,10	3,20	3,30	3,39	3,43							
23,5	23,1	22,7	21,8	20,8	19,6	18,1	16,5							
3,50	3,59	3,87	4,14	4,42	4,58	4,74	4,90							
30,4	29,7	28,9	27,3	25,3	23,1	20,7	18,0	15,2						
4,60	4,70	4,90	4,90	5,40	5,50	5,50	5,60	5,70						
36,6	36,1	35,4	33,9	32,1	30,0	27,8	25,3	22,6						
5,60	5,90	6,20	6,50	6,90	7,10	7,30	7,50	7,60						
42,9	41,8	40,8	38,5	35,9	33,0	29,0	24,5							
7,11	7,46	7,82	8,17	8,33	8,50	8,78	9,06							
48,5	47,7	46,8	44,7	42,2	39,5	35,9	32,0							
8,46	8,81	9,15	9,50	9,85	10,10	10,40	10,64							
56,4	55,7	55,0	53,2	51,3	49,0	46,3	42,8	38,8						
9,49	9,89	10,30	10,71	11,30	11,89	12,30	12,70	13,04						
69,0	68,3	67,6	66,0	64,0	61,5	58,6	55,0	50,5						
12,90	13,40	13,77	14,60	15,50	16,32	17,00	17,68	18,40						
76,1	75,3	74,5	72,8	70,6	68,2	65,5	62,2	58,3						
14,00	14,60	15,30	15,87	16,90	17,88	18,60	19,27	20,22						
87,7	86,9	86,1	84,5	82,7	80,5	78,0	75,2	71,7						
17,60	18,22	19,20	20,10	21,12	22,00	22,96	23,90	24,80						
		90,4	90,2	89,9	89,2	88,2	87,1	86,0	84,8	82,4	79,9	76,9	73,4	
		20,11	21,53	22,91	24,19	25,41	26,59	27,71	28,79	30,91	32,95	34,81	36,56	
		105,0	104,8	104,3	103,7	102,7	101,5	100,3	99,1	96,7	94,1	91,3	88,7	
		23,97	25,62	27,25	28,79	30,21	31,54	32,85	34,15	36,68	39,07	41,26	43,26	
		124,3	124,5	124,7	124,4	123,6	122,5	121,3	119,9	116,6	113,3	110,1	107,1	103,5
		29,30	31,27	33,28	35,14	36,80	38,34	39,85	41,39	44,41	47,32	50,01	52,39	54,83
		146,9	147,3	147,4	147,3	146,9	146,3	145,3	144,1	141,2	137,9	134,1	130,0	125,8
		35,89	38,23	40,53	42,67	44,71	46,70	48,67	50,61	54,26	57,62	60,84	63,78	66,34

MA/MAT - MAX EN 733 ~ 2900 r.p.m.

TYPE	Nominal Power (kW)	Motor Size	Q (m³/h - l/min)													
			0	30	33	36	39	42	48	54	60	66	72	78	84	
			0	500	550	600	650	700	800	900	1000	1100	1200	1300	1400	
			H (m) pump input power (kW)													
65-125B	5,5	132S	20,9 2,3	22,0 3,60	22,0 3,70	21,9 3,80	21,8 3,90	21,7 4,00	21,4 4,30	21,0 4,60	20,6 4,70	20,1 5,00	19,6 5,10	19,0 5,20	18,3 5,40	
65-125A	7,5	132S	25,4 2,8	26,4 4,10	26,4 4,30	26,4 4,60	26,3 4,70	26,3 4,90	26,1 5,20	25,9 5,50	25,6 5,90	25,3 6,10	24,9 6,40	24,5 6,70	24,0 6,90	
65-160C	11	160M	29,8 3,09						31,2 6,00	31,1 6,42	30,8 6,82	30,5 7,21	30,1 7,58	29,6 7,93	29,0 8,25	28,3 8,55
65-160B	11	160M	33 3,49						34,6 6,79	34,4 7,24	34,2 7,67	34,0 8,09	33,7 8,51	33,3 8,91	32,8 9,29	32,1 9,63
65-160A	15	160M	39,2 4,65						40,6 8,10	40,6 8,64	40,4 9,16	40,2 9,66	40,0 10,17	39,7 10,68	39,4 11,19	38,9 11,69
65-200C	15	160M	45,3 4,9								46,3 10,80	45,7 11,30	45,1 11,80	44,3 12,30	43,4 12,90	42,3 13,30
65-200B	18,5	160L	51,6 5,4								52,6 11,60	52,2 12,20	51,8 13,00	51,0 13,80	50,2 14,30	49,3 15,00
65-200A	22	180M	60,2 7,6								61,0 14,90	60,6 15,40	60,1 16,20	59,5 17,10	58,7 17,90	57,8 18,80
65-250B	30	200L	81 10,71								79,5 22,03	78,5 23,12	77,3 24,17	76,0 25,16	74,5 26,08	73,0 26,94
65-250A	37	200L	90 12,09								89,5 24,25	88,5 25,52	87,5 26,73	86,5 27,90	85,5 29,05	84,0 30,15
65-315CN only MA version	55	250M	93,9 15,58								96,5 26,64	96,4 27,98	96,3 29,26	96,0 30,48	95,6 31,67	95,1 32,86
65-315BN only MA version	75	280S	116,5 21,16								117,9 34,28	117,8 35,82	117,7 37,35	117,4 38,80	117,0 40,26	116,4 41,84
65-315AN only MA version	90	280M	138,2 26,69								138,8 43,17	138,5 45,01	138,1 46,88	137,6 48,79	137,0 50,67	136,4 52,51
80-160E	11	160M	21,4 3,70									22,4 6,42	21,1 6,65	21,6 6,86	21,2 7,06	
80-160D	11	160M	25,4 4,28									26,4 7,81	26,1 8,13	25,7 8,44	25,3 8,71	
80-160C	15	160M	29,7 4,90									30,7 9,10	30,5 9,47	30,3 9,84	29,9 10,19	
80-160B	18,5	160L	34,0 6,32									35,0 10,83	35,0 11,24	34,8 11,66	34,6 12,07	
80-160A	22	180M	38,8 7,02									39,8 11,99	39,7 12,46	39,6 12,94	39,4 13,41	
80-200B	30	200L	50,1 9,20													
80-200A	37	200L	56,7 10,58													
80-250B	45	225M	77,2 14,01													
80-250A	55	250M	90,0 16,74													
80-315BN only MA version	90	280M	108,0 21,85												112,4 42,35	112,4 44,06
80-315AN only MA version	110	315S	140,5 31,92												141,4 55,48	141,1 57,36
100-200B	45	225M	56,1 21,75													
100-200A	55	250M	61,1 24,57													
100-250C	55	250M	71,9													
	75	280S	24,75													
100-250B	75	280S	83,6 29,69													
100-250A	90	280M	93,5 32,71													

MA/MAT - MAX EN 733 ~ 2900 r.p.m.

Q (m³/h - l/min)																
96	108	120	132	144	156	168	180	195	210	225	240	255	270	300	330	360
1600	1800	2000	2200	2400	2600	2800	3000	3250	3500	3750	4000	4250	4500	5000	5500	6000
H (m)																
pump input power (kW)																
16,6	14,7	12,6														
5,40	5,80	5,90														
22,7	21,0	18,9	16,5													
7,20	7,50	7,70	7,80													
26,6	24,6	22,1	19,3	16,0												
9,09	9,56	9,95	10,23	10,43												
30,6	28,8	26,7	24,1	21,1												
10,28	10,85	11,32	11,70	12,16												
37,7	36,2	34,3	32,2	29,8												
12,66	13,55	14,34	14,93	15,55												
39,8	36,7	32,7	28,0													
13,80	14,90	15,40	15,80													
47,1	44,1	40,9	36,6	31,3												
16,00	16,70	17,50	18,20	18,60												
55,8	53,1	49,8	46,1	41,7												
19,80	20,90	22,00	22,80	23,30												
69,3	65,0	60,0	54,5	48,5												
28,60	30,01	31,18	32,16	33,14												
80,5	76,5	72,0	66,5	60,5	54,0											
32,07	33,78	35,41	36,76	37,84	38,67											
93,8	92,3	90,7	89,1	87,5	85,5	83,2	80,8									
35,28	37,62	39,76	41,93	44,18	46,34	48,31	50,27									
114,9	113,3	111,4	109,4	107,2	104,9	102,5	99,9	96,3								
45,05	47,87	50,51	53,05	55,48	57,76	59,94	62,26	65,43								
135,0	133,5	131,7	129,5	127,0	124,5	121,8	118,8	114,8	110,4							
56,09	59,52	62,82	66,09	69,20	72,02	74,81	77,32	80,16	83,11							
20,2	19,2	18,0	16,8	15,4	13,7	12,0										
7,41	7,66	7,93	8,22	8,39	8,48	8,53										
24,4	23,6	22,5	21,3	20,0	18,5	16,9	15,1									
9,11	9,45	9,79	10,14	10,50	10,71	10,83	10,97									
29,2	28,1	27,1	26,0	24,7	23,1	21,5	19,7	17,2								
10,81	11,34	11,86	12,35	12,75	13,09	13,36	13,53	13,61								
34,0	33,3	32,5	31,6	30,5	29,2	27,8	26,0	23,6	21,0							
12,83	13,54	14,25	14,91	15,49	15,99	16,42	16,76	17,04	17,23							
38,9	38,2	37,5	36,7	35,7	34,5	33,2	31,6	29,4	26,8	23,5						
14,30	15,13	15,96	16,76	17,50	18,18	18,77	19,29	19,81	20,30	19,95						
53,5	52,7	51,8	50,9	49,9	48,5	46,9	45,2	42,9	40,4	37,7						
19,70	20,92	21,99	23,00	23,95	24,85	25,69	26,46	27,32	28,05	28,62						
60,6	59,9	59,1	58,1	57,2	56,0	54,4	52,7	50,7	48,3	45,6	42,4					
22,62	24,07	25,46	26,77	27,92	29,07	30,29	31,35	32,45	33,46	34,35	35,12					
80,0	79,0	77,5	75,3	73,1	71,0	69,0	67,0	64,5	61,8	58,8						
30,93	32,60	34,34	36,16	37,86	39,38	40,78	42,10	43,60	44,94	46,15						
92,8	91,1	89,3	87,4	85,4	83,1	80,7	78,5	75,7	72,4	68,8	65,2					
36,56	38,57	40,54	42,46	44,31	46,11	47,81	49,29	50,92	52,59	54,18	55,50					
112,2	111,7	111,1	110,2	109,1	107,9	106,4	104,9	102,7	100,4	98,3	95,7	90,8				
47,49	50,85	54,13	57,25	60,24	63,14	65,95	68,74	72,14	75,50	78,97	82,35	85,17				
140,2	139,2	138,1	136,9	135,5	134,1	132,5	131,0	128,7	125,8	122,5	121,7	118,5				
61,13	64,93	68,78	72,88	76,96	80,84	84,36	86,98	90,23	94,71	99,35	102,58	106,15				
	56,8	56,5	56,1	55,6	55,1	54,5	53,9	53,1	52,2	51,4	50,4	49,0	47,5	43,8	39,7	
	28,84	29,75	30,73	31,75	32,80	33,89	35,07	36,55	37,82	38,89	39,85	40,77	41,60	42,92	43,82	
	62,2	61,8	61,5	61,0	60,5	59,9	59,5	58,9	58,3	57,4	56,4	55,2	53,8	50,6	46,8	42,5
	33,04	34,05	35,09	36,18	37,29	38,39	39,49	40,87	42,23	43,60	44,97	46,20	47,28	49,05	50,53	51,62
		73,2	73,1	72,9	72,6	72,2	71,8	71,1	70,3	69,3	67,9	66,4	64,7	61,0		
		40,12	41,93	43,70	45,31	46,77	48,15	49,88	51,65	53,38	55,05	56,66	58,19	60,99		
		83,7	83,5	83,2	82,9	82,5	82,1	81,4	80,8	80,0	79,0	77,9	76,4	72,0	67,6	
		47,10	49,07	51,01	52,90	54,76	56,55	58,56	60,26	61,86	63,51	65,17	66,93	70,91	73,78	
		93,9	93,7	93,4	92,9	92,4	91,8	90,9	89,9	88,8	87,4	85,7	84,0	80,4	75,8	73,2
		51,99	54,16	56,31	58,44	60,60	62,70	65,02	66,97	68,84	70,82	72,81	74,73	78,17	81,33	85,53

32-160

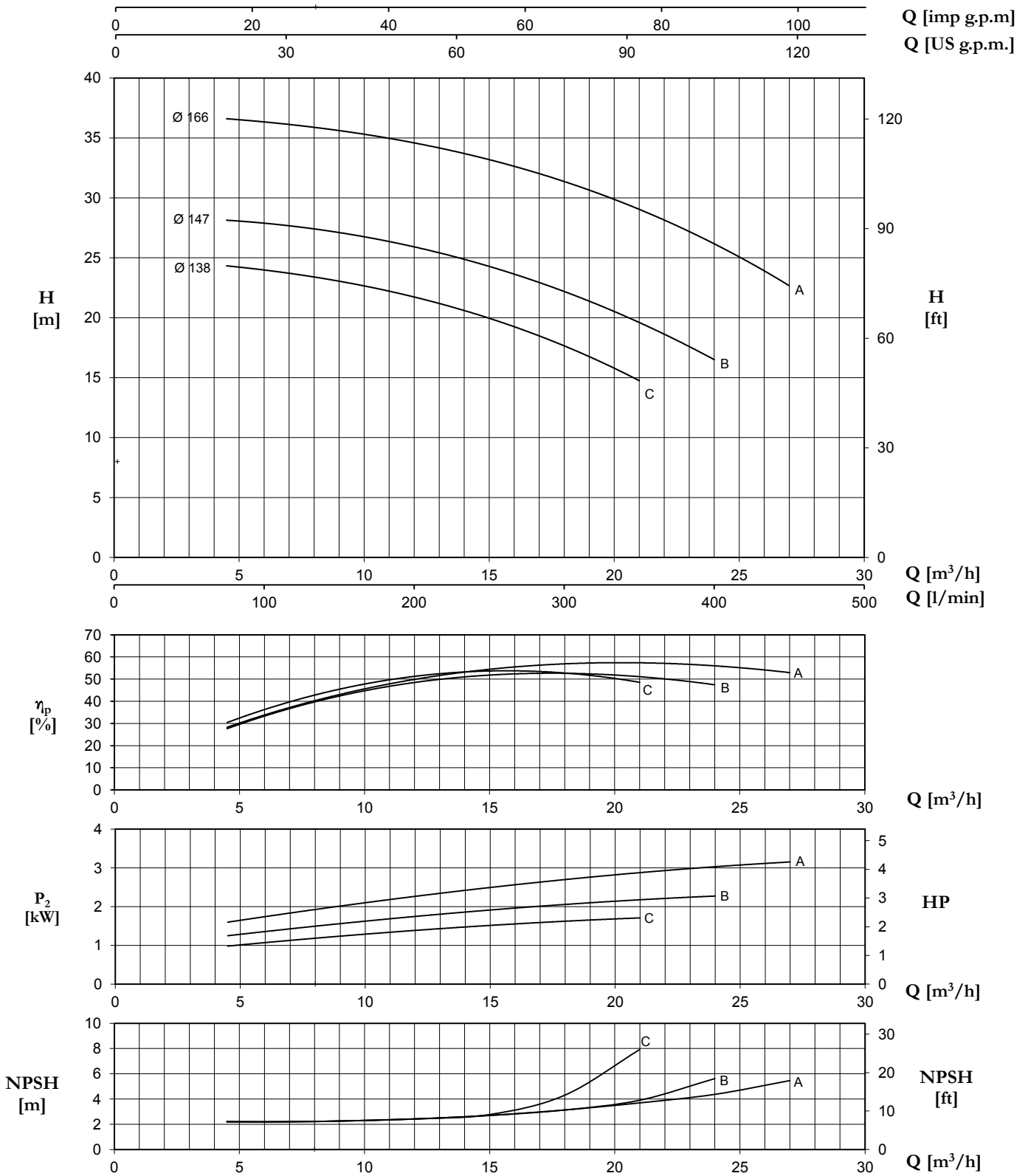

Tolerance: ISO 9906:2012 - Grade 3B

TYPE	Nominal Power (kW)	Motor Size	Q (m³/h - l/min)										
			0	4,5	6	9	12	15	18	21	24	27	
			0	75	100	150	200	250	300	350	400	450	
H (m) / pump input power (kW)													
32-160C	1,5	90S	24,4	24,3	24,0	23,0	21,8	20,0	17,5	14,8			
	2,2	90L	0,73	0,98	1,07	1,24	1,39	1,52	1,62	1,71			
32-160B	2,2	90L	28,1	28,2	27,9	27,0	25,9	24,4	22,2	19,5	16,6		
32-160A	3	100L	0,97	1,25	1,36	1,56	1,75	1,92	2,06	2,17	2,28		
			36,8	36,6	36,4	35,6	34,5	33,2	31,5	29,1	26,0	22,8	
			1,24	1,61	1,74	2,01	2,27	2,50	2,70	2,88	3,03	3,16	

MA/MAT - MAX EN 733 ~ 2900 r.p.m.

32-200

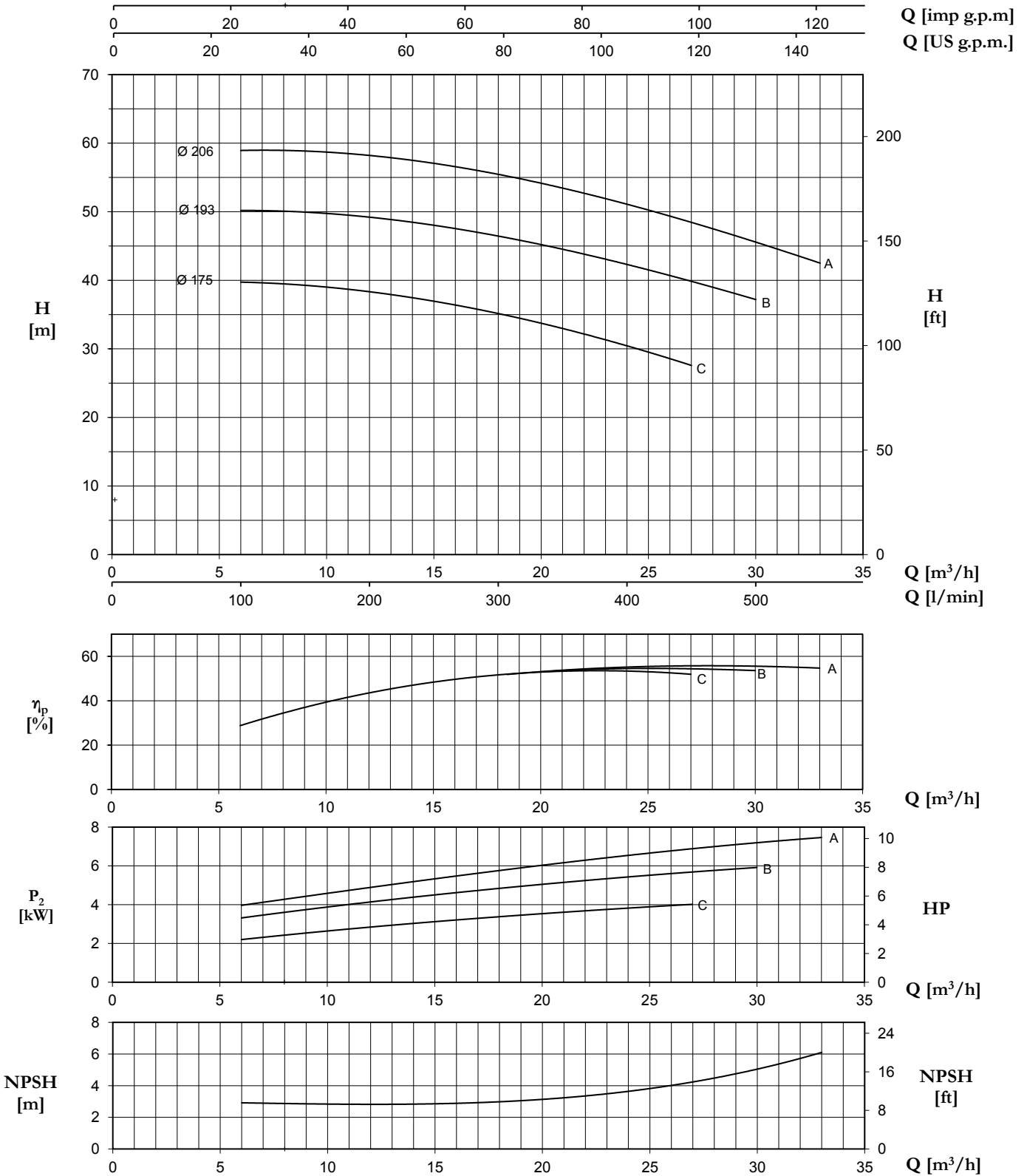

Tolerance: ISO 9906:2012 - Grade 3B

TYPE	Nominal Power (kW)	Motor Size	Q (m³/h - l/min)										
			0	6	9	12	15	21	24	27	30	33	
			0	100	150	200	250	350	400	450	500	550	
H (m) / pump input power (kW)													
32-200C	4	112M	40,1 1,52	39,7 2,20	39,3 2,53	38,3 2,84	36,9 3,13	33,0 3,61	30,4 3,82	27,6 4,02			
32-200B	5,5	132S	50,1 2,34	50,2 3,31	49,9 3,75	49,3 4,14	48,0 4,50	44,5 5,15	42,4 5,43	39,8 5,69	37,2 5,92		
32-200A	7,5	132S	58,6 3,03	59,0 3,96	58,8 4,43	58,2 4,90	57,1 5,36	53,4 6,11	51,1 6,52	48,4 6,92	45,6 7,22	42,5 7,45	

32-250

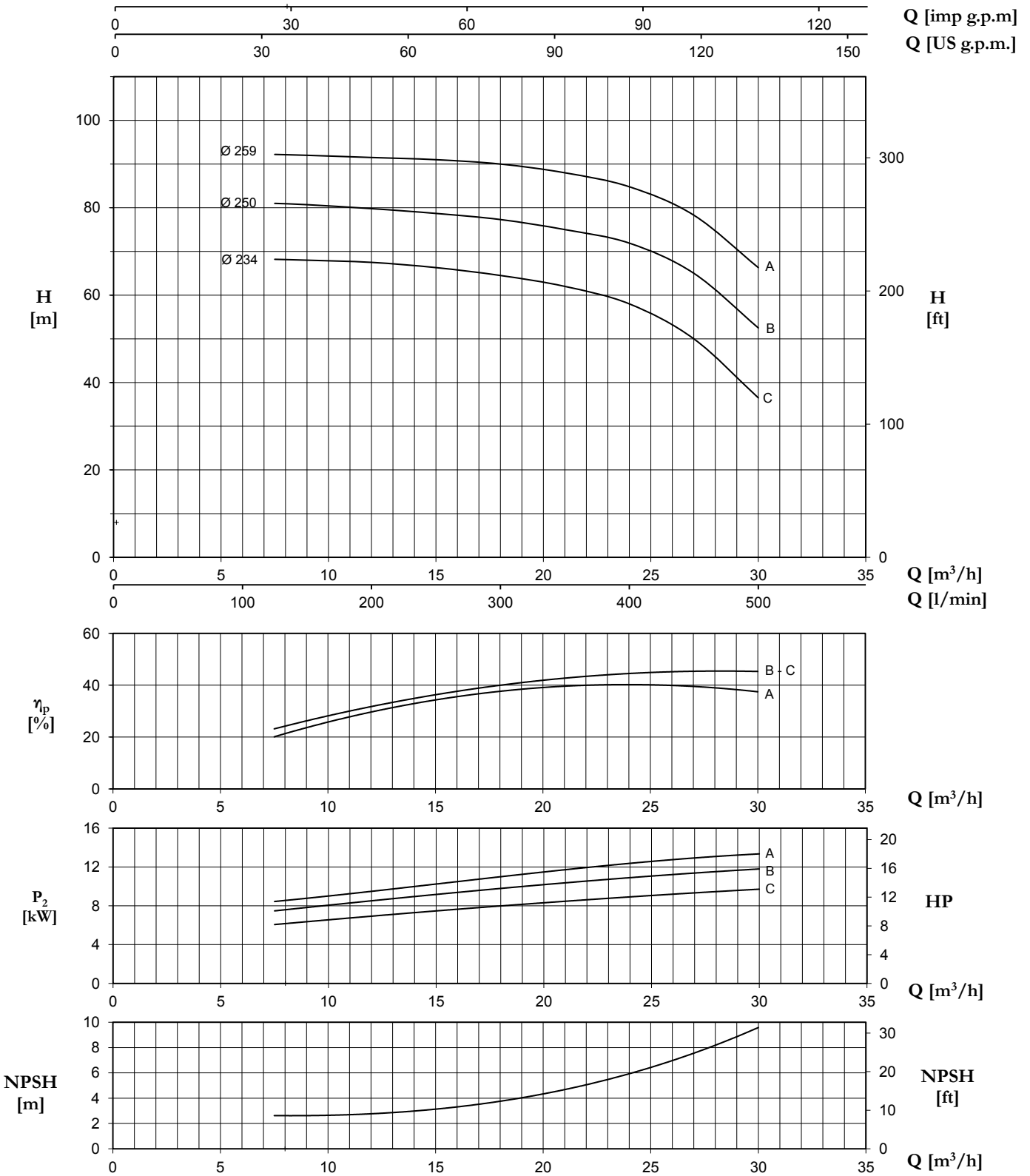

Tolerance: ISO 9906:2012 - Grade 3B

TYPE	Nominal Power (kW)	Motor Size	Q (m³/h - l/min)										
			0	7,5	9	12	15	18	21	24	27	30	
			0	125	150	200	250	300	350	400	450	500	
H (m) / pump input power (kW)													
32-250C	11	160M	70,0	68,5	68,0	67,0	65,5	63,5	61	58	50	36,5	
			4,89	6,15	6,48	7,11	7,74	8,19	8,54	8,89	9,24	9,63	
32-250B	11	160M	82,0	81,0	80,5	79,5	78,5	77,0	74,5	71,9	65	52,5	
	15	160M	6,45	8,02	8,35	9,00	9,56	10,1	10,5	11,2	11,8	12,1	
32-250A	15	160M	93,0	92,5	92,0	91,5	90,5	89,5	87,5	85	78,5	66	
			7,85	9,30	9,88	10,7	11,4	12,2	12,9	13,6	14,3	14,9	

40-125

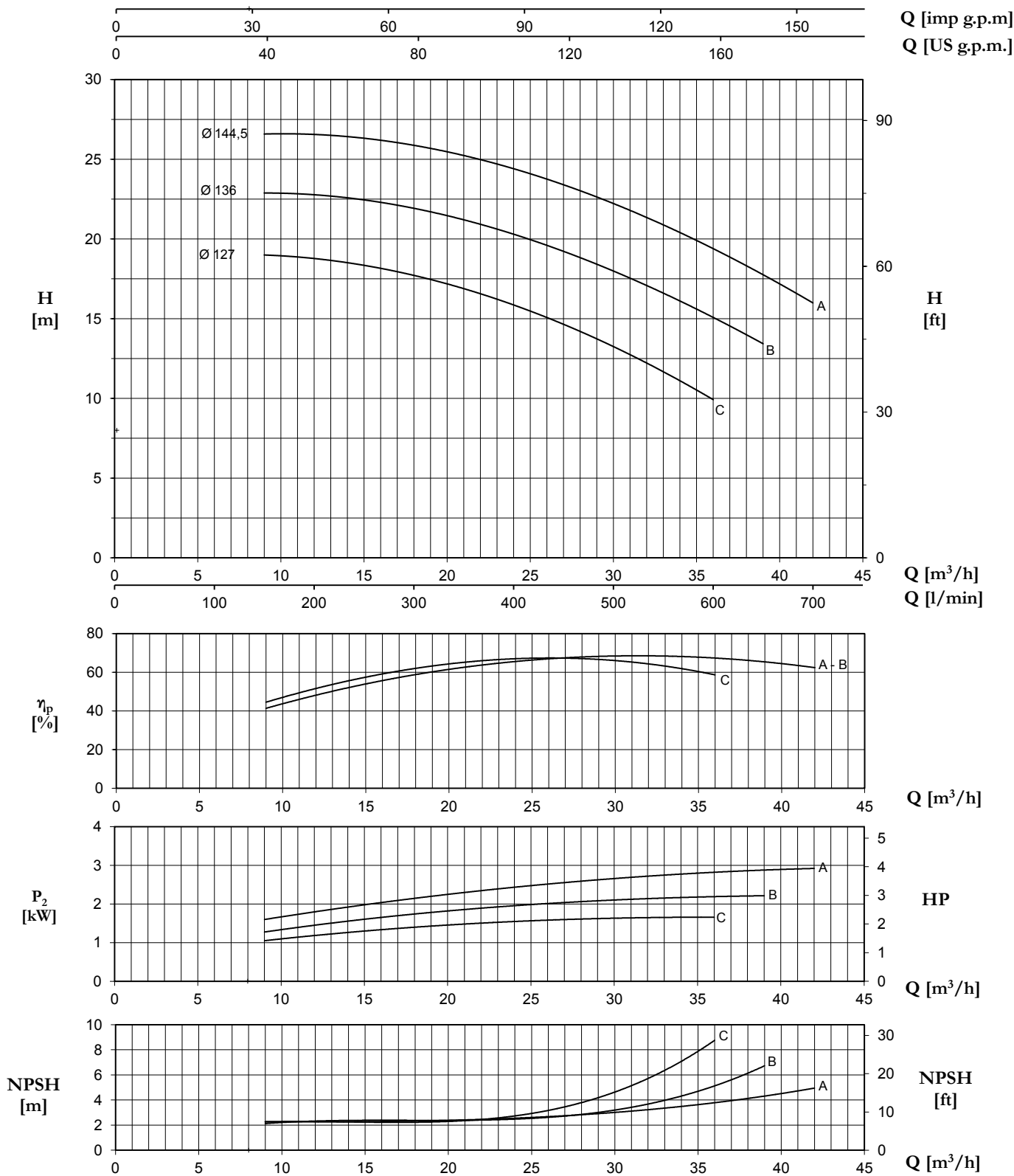

Tolerance: ISO 9906:2012 - Grade 3B

TYPE	Nominal Power (kW)	Motor Size	Q (m³/h - l/min)												
			0	9	15	21	27	30	33	36	39	42			
			0	150	250	350	450	500	550	600	650	700			
H (m) / pump input power (kW)															
40-125C	1,5	90S	18,9 0,69	19,0 1,05	18,3 1,30	16,9 1,48	14,7 1,60	13,2 1,63	11,6 1,65	9,9 1,66					
40-125B	2,2	90L	22,5 0,86	22,9 1,28	22,5 1,60	21,2 1,86	19,2 2,04	18,0 2,10	16,7 2,15	15,2 2,19	13,4 2,22				
40-125A	3	100L	26,2 1,11	26,6 1,60	26,3 1,98	25,2 2,30	23,4 2,55	22,2 2,66	20,9 2,75	19,4 2,82	17,8 2,87	16,0 2,92			

MA/MAT - MAX EN 733 ~ 2900 r.p.m.

40-160

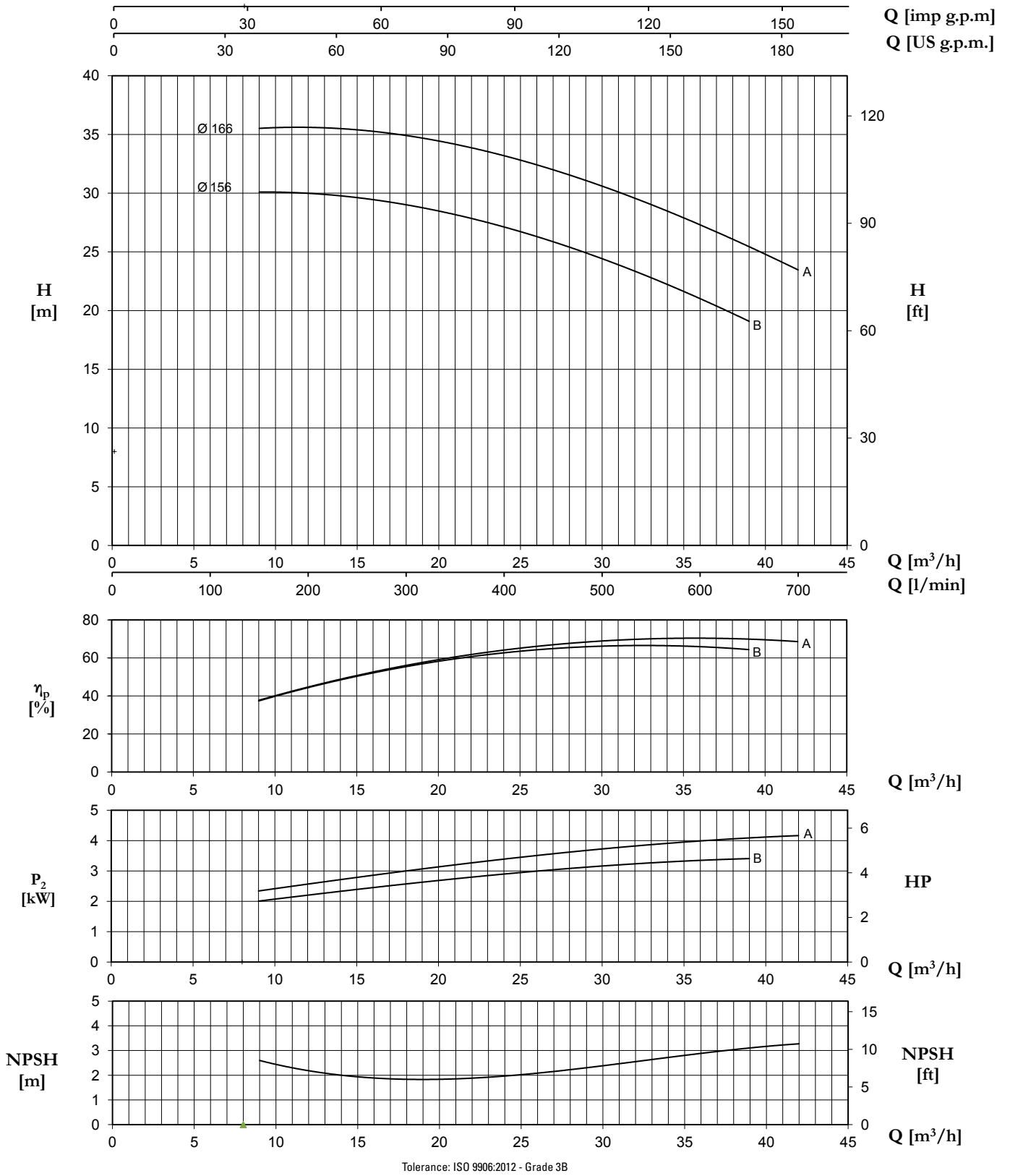

Tolerance: ISO 9906:2012 - Grade 3B

TYPE	Nominal Power (kW)	Motor Size	Q (m³/h - l/min)													
			0	9	12	15	18	21	24	27	30	33	36	39	42	
			0	150	200	250	300	350	400	450	500	550	600	650	700	
H (m) / pump input power (kW)																
40-160B	3	100L	30,0	30,1	30,0	29,6	29,0	28,2	27,1	25,9	24,4	22,8	21,0	19,1		
	4	112M	1,39	2,00	2,20	2,38	2,57	2,75	2,91	3,04	3,16	3,26	3,35	3,41		
40-160A	4	112M	35,4	35,6	35,5	35,3	35,0	34,2	33,2	32,0	30,6	29,0	27,3	25,4	23,5	
	5,5	132S	1,64	2,36	2,55	2,78	3,00	3,21	3,40	3,56	3,72	3,86	3,99	4,08	4,17	

MA/MAT - MAX EN 733 ~ 2900 r.p.m.

40-200

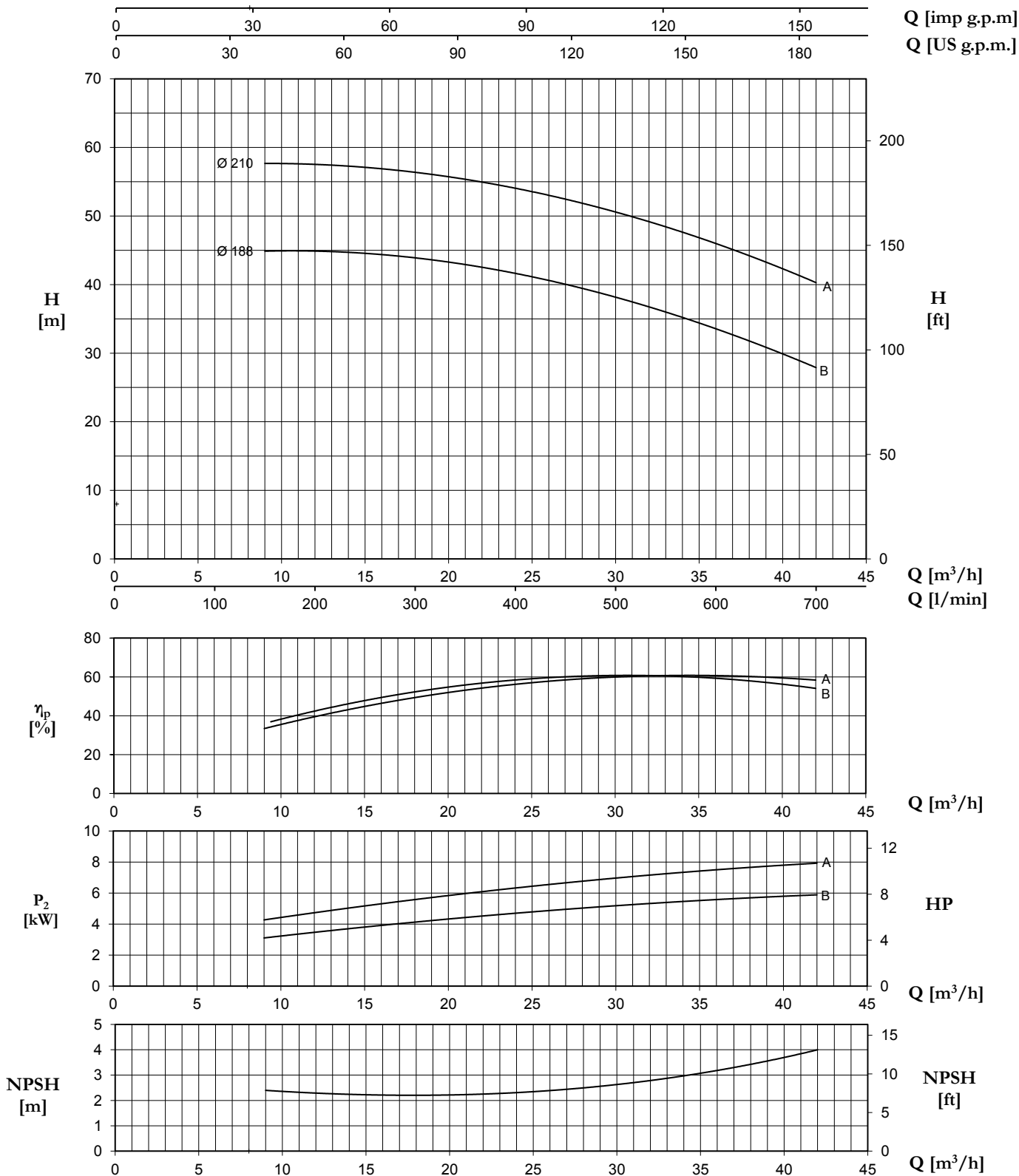

Tolerance: ISO 9906:2012 - Grade 3B

TYPE	Nominal Power (kW)	Motor Size	Q (m³/h - l/min)													
			0	9	12	15	18	21	24	27	30	33	36	39	42	
			0	150	200	250	300	350	400	450	500	550	600	650	700	
H (m) / pump input power (kW)																
40-200B	5,5	132S	44,7	44,9	44,8	44,6	44,0	42,9	41,6	40,0	38,1	36,1	33,6	30,8	27,9	
			2,3	3,3	3,6	3,8	4,2	4,6	4,6	5,0	5,3	5,4	5,6	5,7	6,0	
40-200A	7,5	132S	57,7	57,7	57,5	57,1	56,3	55,4	54,1	52,5	50,5	48,5	45,9	43,3	40,3	
			3,2	4,3	4,6	5,2	5,6	6,1	6,4	6,7	7,1	7,4	7,6	7,9	8,0	

MA/MAT - MAX EN 733 ~ 2900 r.p.m.

40-250

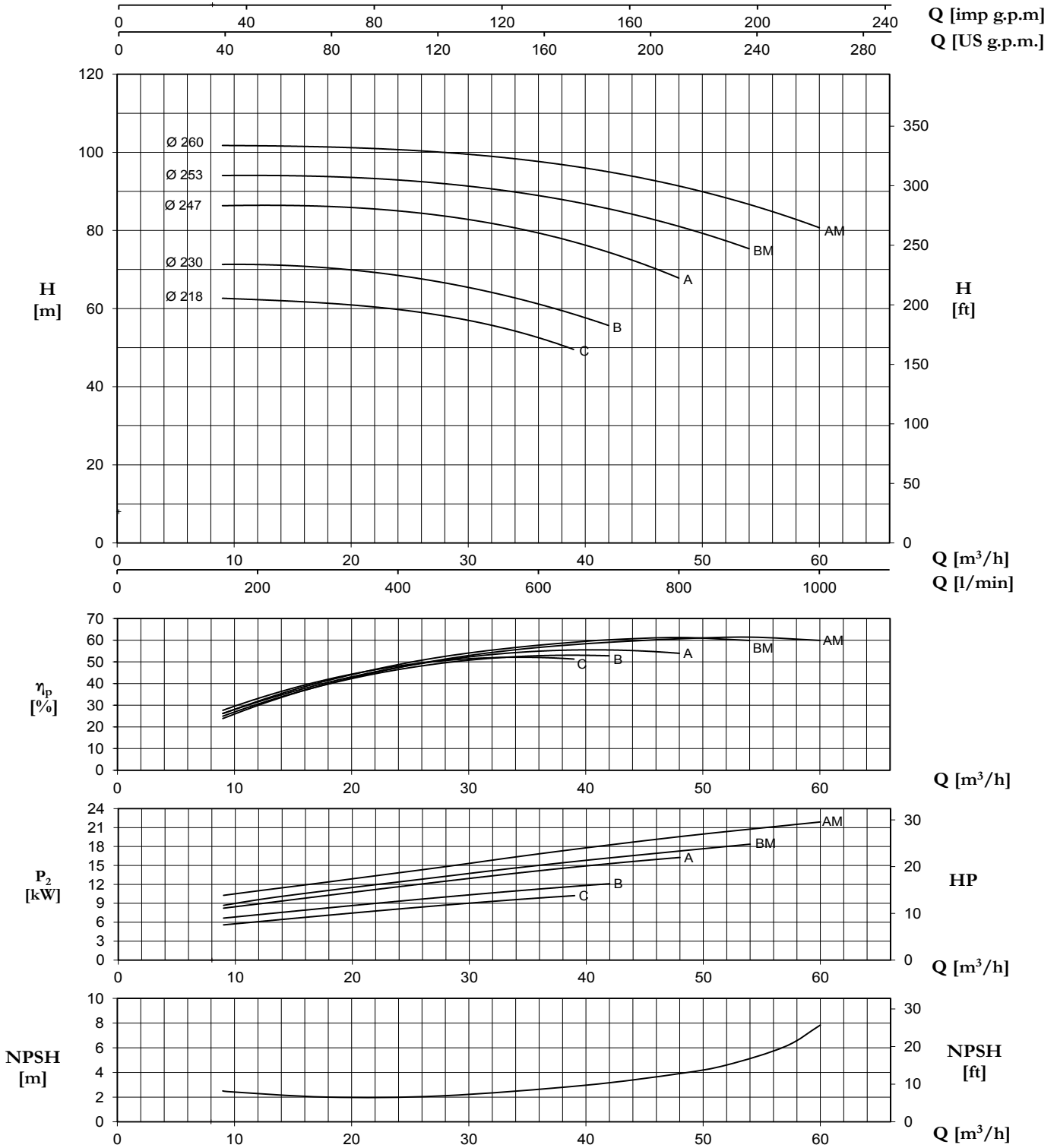

Tolerance: ISO 9906:2012 - Grade 3B

TYPE	Nominal Power (kW)	Motor Size	Q (m³/h - l/min)										
			0	9	15	21	27	36	39	42	48	54	60
			0	150	250	350	450	600	650	700	800	900	1000
H (m) / pump input power (kW)													
40-250C	11	160M	63,0	62,6	61,9	60,5	58,6	52,4	49,6				
			4,40	5,60	6,61	7,63	8,57	9,83	10,22				
40-250B	11	160M	70,8	71,3	71,0	69,8	66,6	61,2	58,5	55,6			
	15	160M	5,16	6,65	7,76	8,80	9,86	11,25	11,69	12,11			
40-250A	15	160M	86,1	86,3	86,4	85,6	84,1	79,4	77,0	74,3	67,9		
	18,5	160L	6,70	8,24	9,58	10,97	12,31	14,13	14,74	15,32	16,27		
40-250BM*	18,5	160L	93,1	93,8	94,2	93,4	92,2	88,8	87,3	85,6	81,4	75,1	
			6,81	8,68	10,35	11,73	13,06	15,03	15,63	16,20	17,29	18,37	
40-250AM*	22	180M	101,6	101,9	101,4	101,0	100,3	97,8	96,3	94,6	91,2	87,0	80,6
			8,99	10,26	11,69	13,13	14,57	16,85	17,56	18,26	19,57	20,75	21,89

(*): max 14 bar

MA/MAT - MAX EN 733 ~ 2900 r.p.m.

50-125

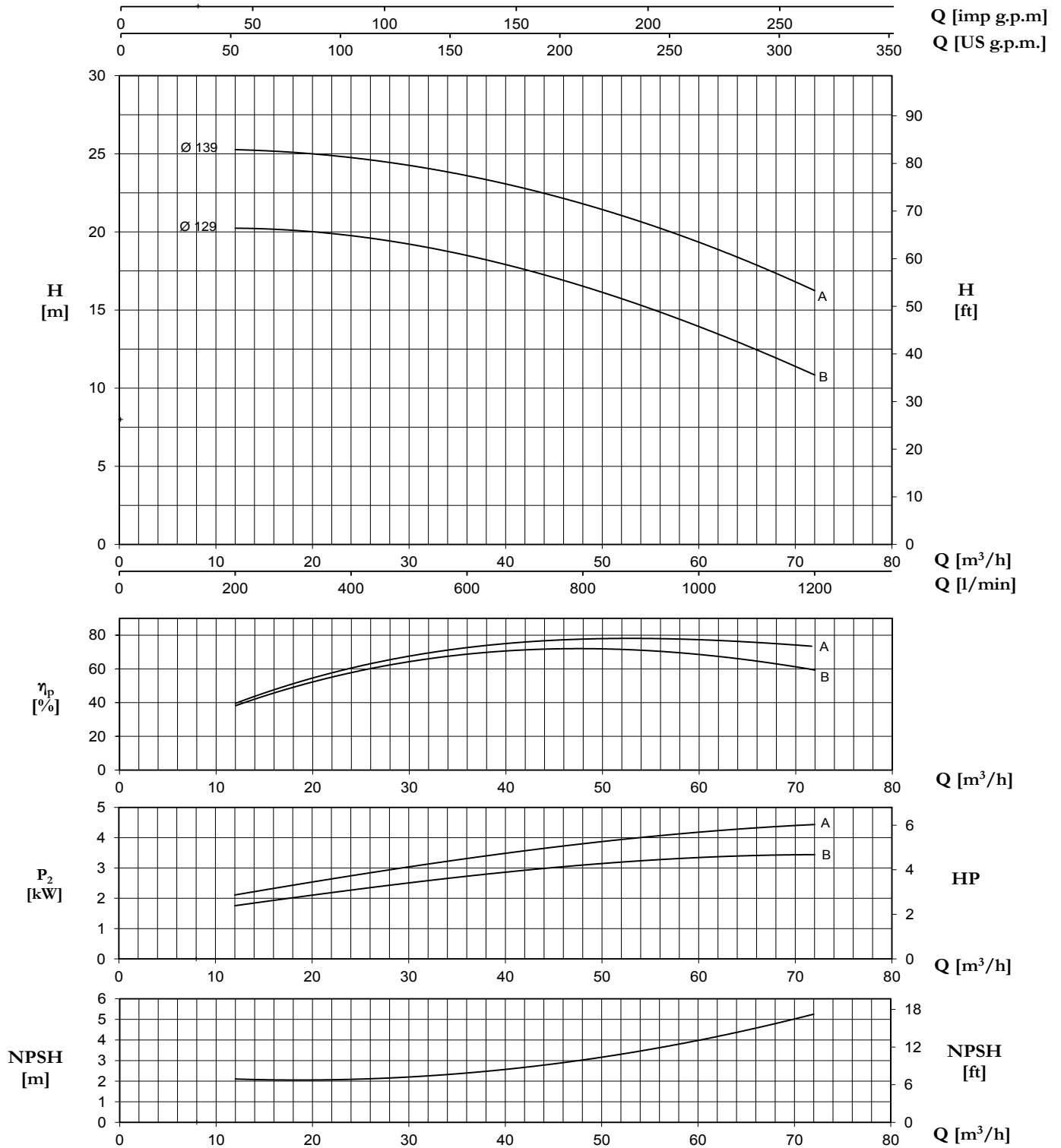

Tolerance: ISO 9906:2012 - Grade 3B

TYPE	Nominal Power (kW)	Motor Size	Q (m³/h - l/min)																
			0	12	15	18	21	24	27	30	33	36	39	42	48	54	60	66	72
			0	200	250	300	350	400	450	500	550	600	650	700	800	900	1000	1100	1200
			H (m) / pump input power (kW)																
50-125B	3	100L	19,9	20,2	20,2	20,1	20,0	19,8	19,3	19,1	18,7	18,3	17,8	17,4	16,4	15,3	14,0	12,7	11,2
	4	112M	1,22	1,77	1,94	2,11	2,22	2,33	2,44	2,55	2,65	2,76	2,87	2,98	3,10	3,20	3,30	3,39	3,43
50-125A	4	112M	24,5	25,0	24,9	24,8	24,6	24,4	24,2	23,8	23,5	23,1	22,7	21,8	20,8	19,6	18,1	16,5	
	5,5	132S	1,78	2,54	2,70	2,85	3,01	3,17	3,33	3,42	3,50	3,59	3,87	4,14	4,42	4,58	4,74	4,90	

MA/MAT - MAX EN 733 ~ 2900 r.p.m.

50-160

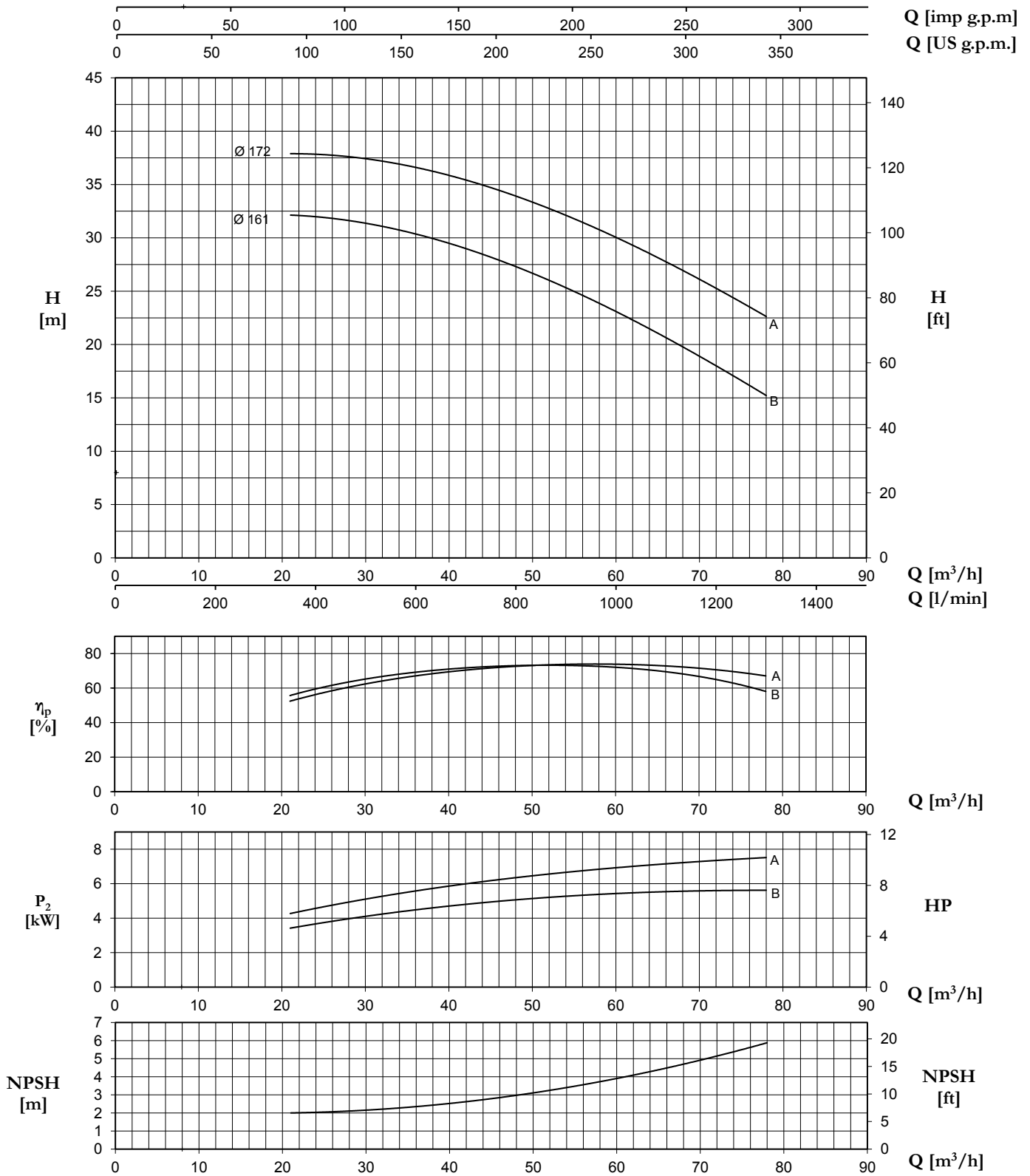

Tolerance: ISO 9906:2012 - Grade 3B

TYPE	Nominal Power (kW)	Motor Size	Q (m³/h - l/min)														
			0	21	24	27	30	33	36	39	42	48	54	60	66	72	78
			0	350	400	450	500	550	600	650	700	800	900	1000	1100	1200	1300
			H (m) / pump input power (kW)														
50-160B	5,5	132S	31,1 2,1	32,1 3,6	32,0 3,8	31,7 4,0	31,4 4,2	31,0 4,4	30,4 4,6	29,7 4,7	28,9 4,9	27,3 4,9	25,3 5,4	23,1 5,5	20,7 5,5	18,0 5,6	15,2 5,7
50-160A	7,5	132S	36,7 2,6	37,9 4,2	37,8 4,5	37,7 4,9	37,4 5,1	37,1 5,4	36,6 5,6	36,1 5,9	35,4 6,2	33,9 6,5	32,1 6,9	30,0 7,1	27,8 7,3	25,3 7,5	22,6 7,6

50-200

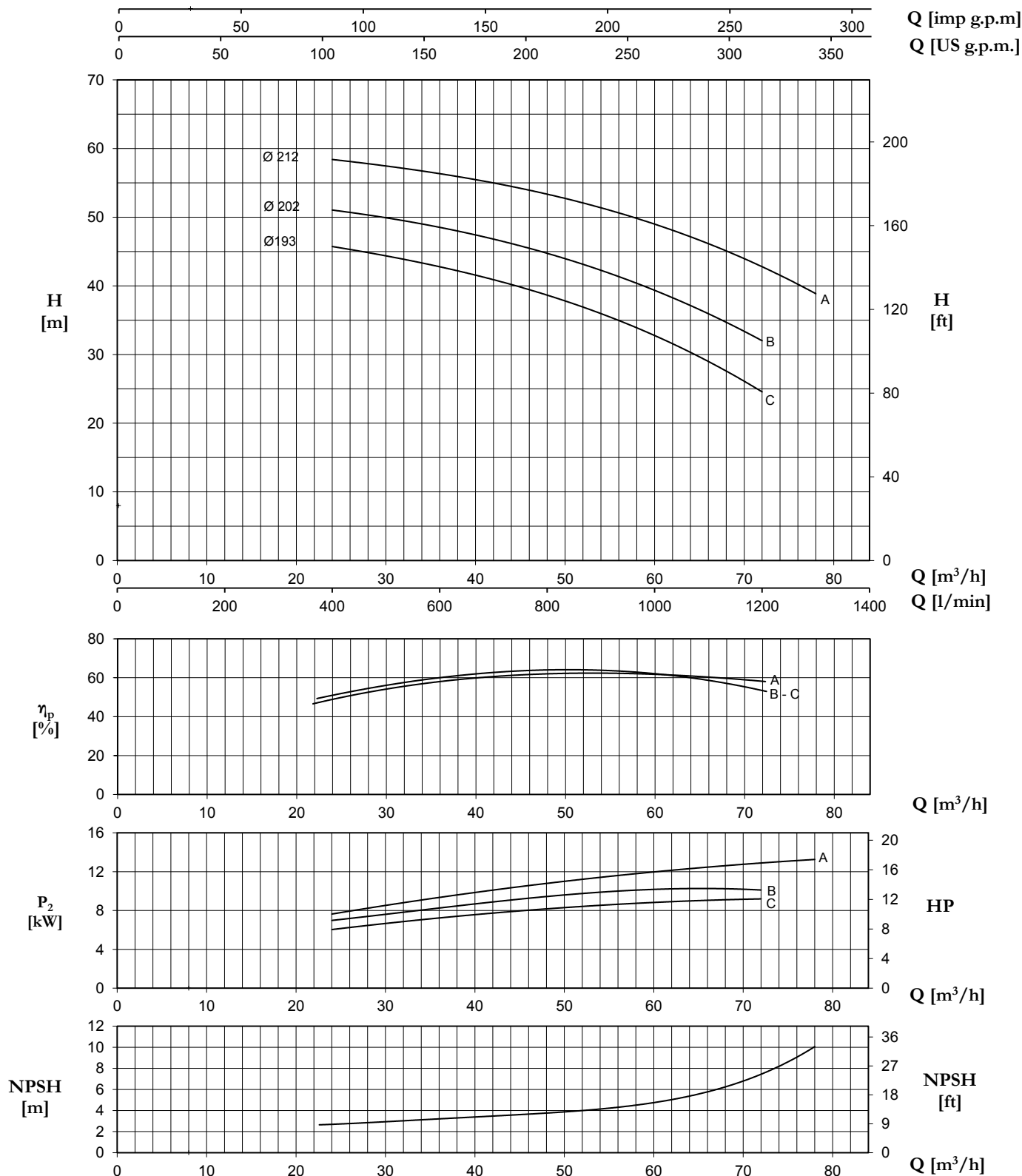

Tolerance: ISO 9906:2012 - Grade 3B

TYPE	Nominal Power (kW)	Motor Size	Q (m³/h - l/min)													
			0	24	27	30	33	36	39	42	48	54	60	66	72	78
			0	400	450	500	550	600	650	700	800	900	1000	1100	1200	1300
			H (m) / pump input power (kW)													
50-200C	11	160M	46,0 3,25	45,6 6,08	45,1 6,30	44,5 6,53	43,7 6,76	42,9 7,11	41,8 7,46	40,8 7,82	38,5 8,17	35,9 8,33	33,0 8,50	29,0 8,78	24,5 9,06	
50-200B	11	160M	50,8 3,38	51,0 6,68	50,5 7,53	50,0 7,80	49,3 8,20	48,5 8,46	47,7 8,81	46,8 9,15	44,7 9,50	42,2 9,85	39,5 10,1	35,9 10,4	32,0 10,6	
50-200A	15	160M	58,0 4,63	58,3 7,89	58,0 8,28	57,5 8,67	57,0 9,08	56,4 9,49	55,7 9,89	55,0 10,3	53,2 10,7	51,3 11,3	49,0 11,9	46,3 12,3	42,8 12,7	38,8 13,0

MA/MAT - MAX EN 733 ~ 2900 r.p.m.

50-250

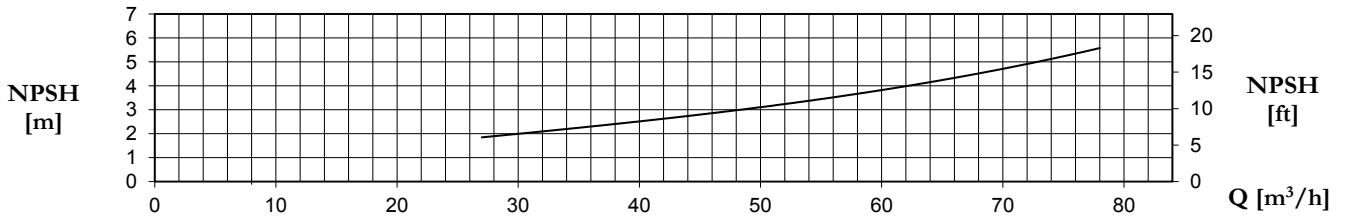
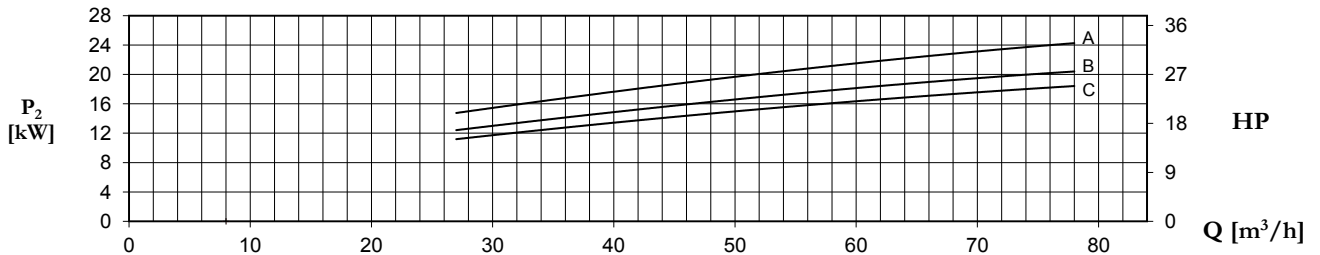
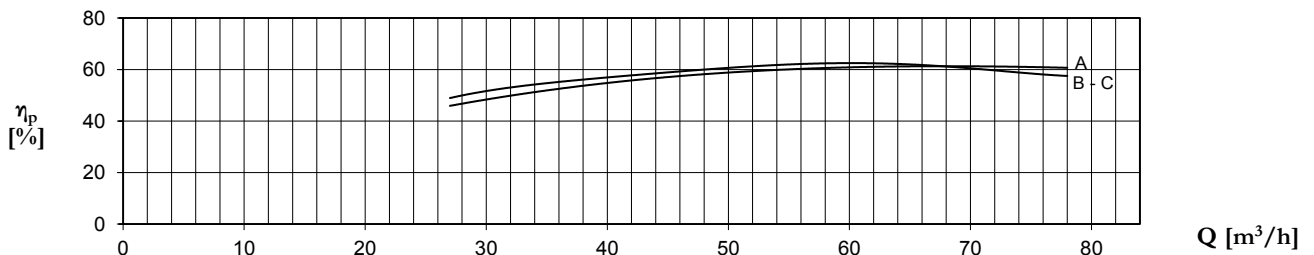
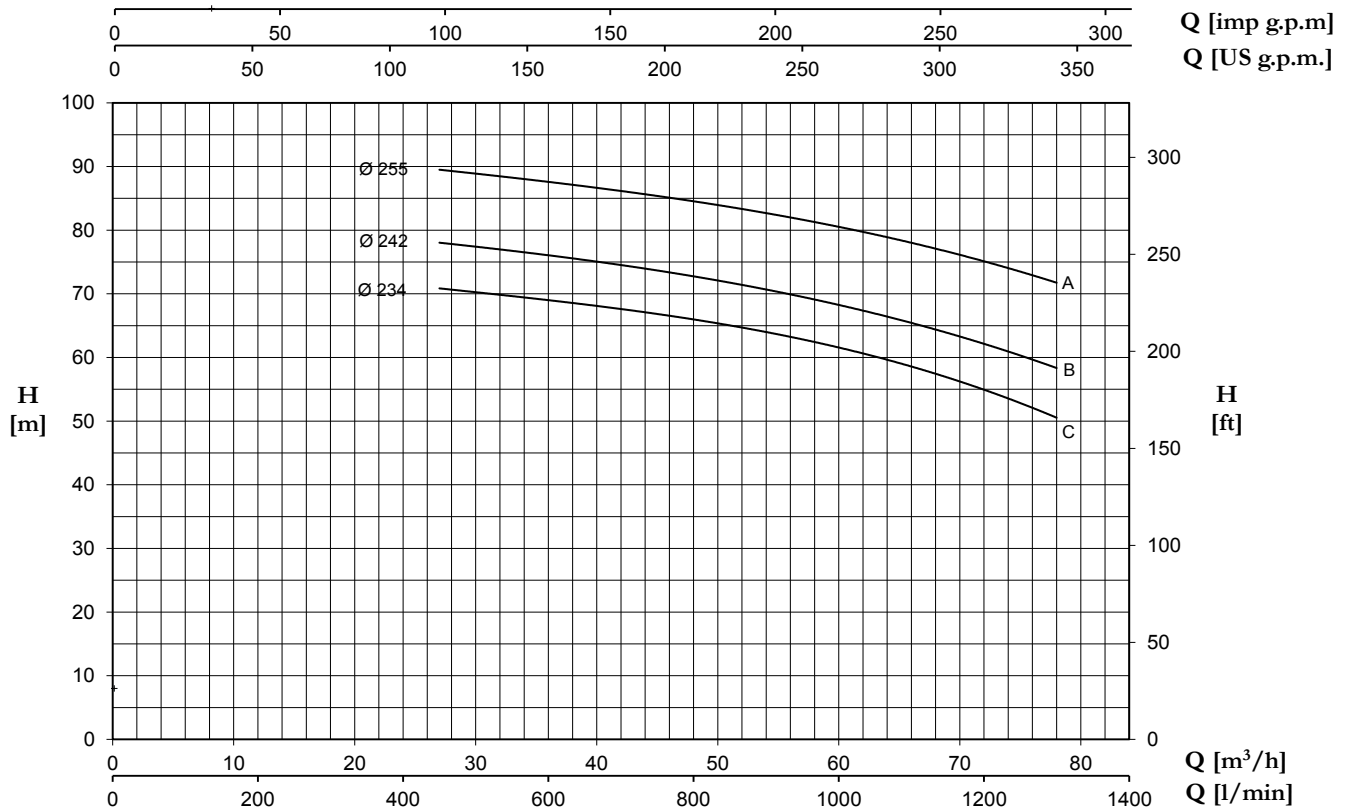

Tolerance: ISO 9906:2012 - Grade 3B

TYPE	Nominal Power (kW)	Motor Size	Q (m³/h - l/min)													
			0	27	30	33	36	39	42	48	54	60	66	72	78	
			0	450	500	550	600	650	700	800	900	1000	1100	1200	1300	
			H (m) / pump input power (kW)													
50-250C	15	160M	71,5	70,8	70,3	69,7	69,0	68,3	67,6	66,0	64,0	61,5	58,6	55,0	50,5	
	18,5	160L	6,74	11,3	11,9	12,5	12,9	13,4	13,8	14,6	15,5	16,3	17,0	17,7	18,4	
50-250B	18,5	160L	78,0	78,0	77,4	76,8	76,1	75,3	74,5	72,8	70,6	68,2	65,5	62,2	58,3	
	22	180M	6,87	12,0	12,7	13,3	14,0	14,6	15,3	15,9	16,9	17,9	18,6	19,3	20,2	
50-250A	22	180M	90,0	89,5	88,8	88,3	87,7	86,9	86,1	84,5	82,7	80,5	78,0	75,2	71,7	
	30	200L	10,1	15,6	16,3	17,0	17,6	18,2	19,2	20,1	21,1	22,0	23,0	23,9	24,8	

MA (No EN 733; only MA version) ~ 2900 r.p.m.

50-315

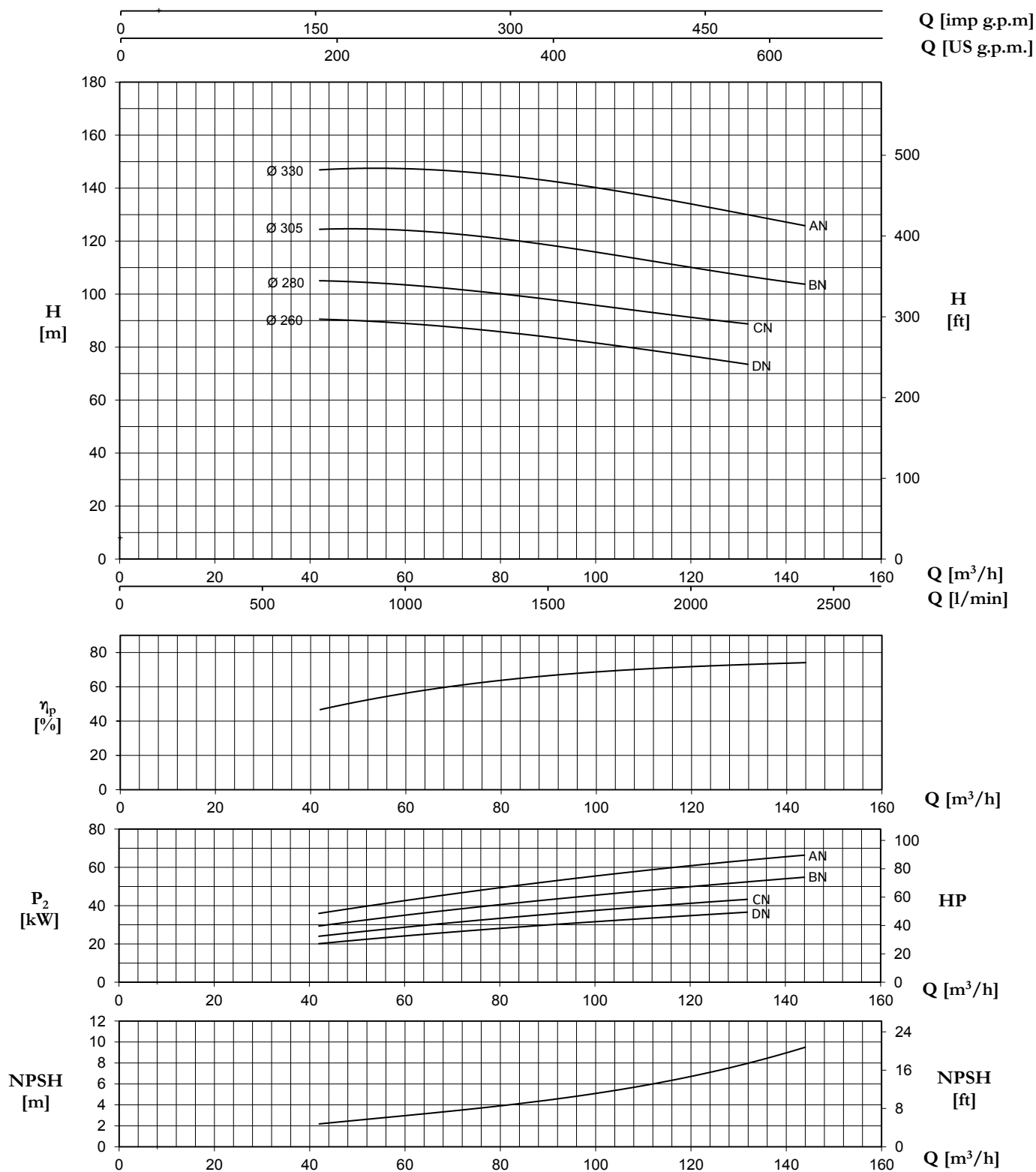

Tolerance: ISO 9906:2012 - Grade 3B

TYPE	Nominal Power (kW)	Motor Size	Q (m³/h - l/min)								
			0	42	54	66	78	96	120	132	144
			0	700	900	1100	1300	1600	2000	2200	2400
H (m) / pump input power (kW)											
50-315DN	37	200L	87,8 11,19	90,4 20,11	89,9 22,91	88,2 25,41	86,0 27,71	82,4 30,91	76,9 34,81	73,4 36,56	
50-315CN	45	225M	101,8 13,32	105,0 23,97	104,3 27,25	102,7 30,21	100,3 32,85	96,7 36,68	91,3 41,26	88,7 43,26	
50-315BN	55	250M	122,3 17,44	124,3 29,30	124,7 33,28	123,6 36,80	121,3 39,85	116,6 44,41	110,1 50,01	107,1 52,39	103,5 54,83
50-315AN	75	280S	146,1 22,75	146,9 35,89	147,4 40,53	146,9 44,71	145,3 48,67	141,2 54,26	134,1 60,84	130,0 63,78	125,8 66,34

MA/MAT - MAX EN 733 ~ 2900 r.p.m.

65-125

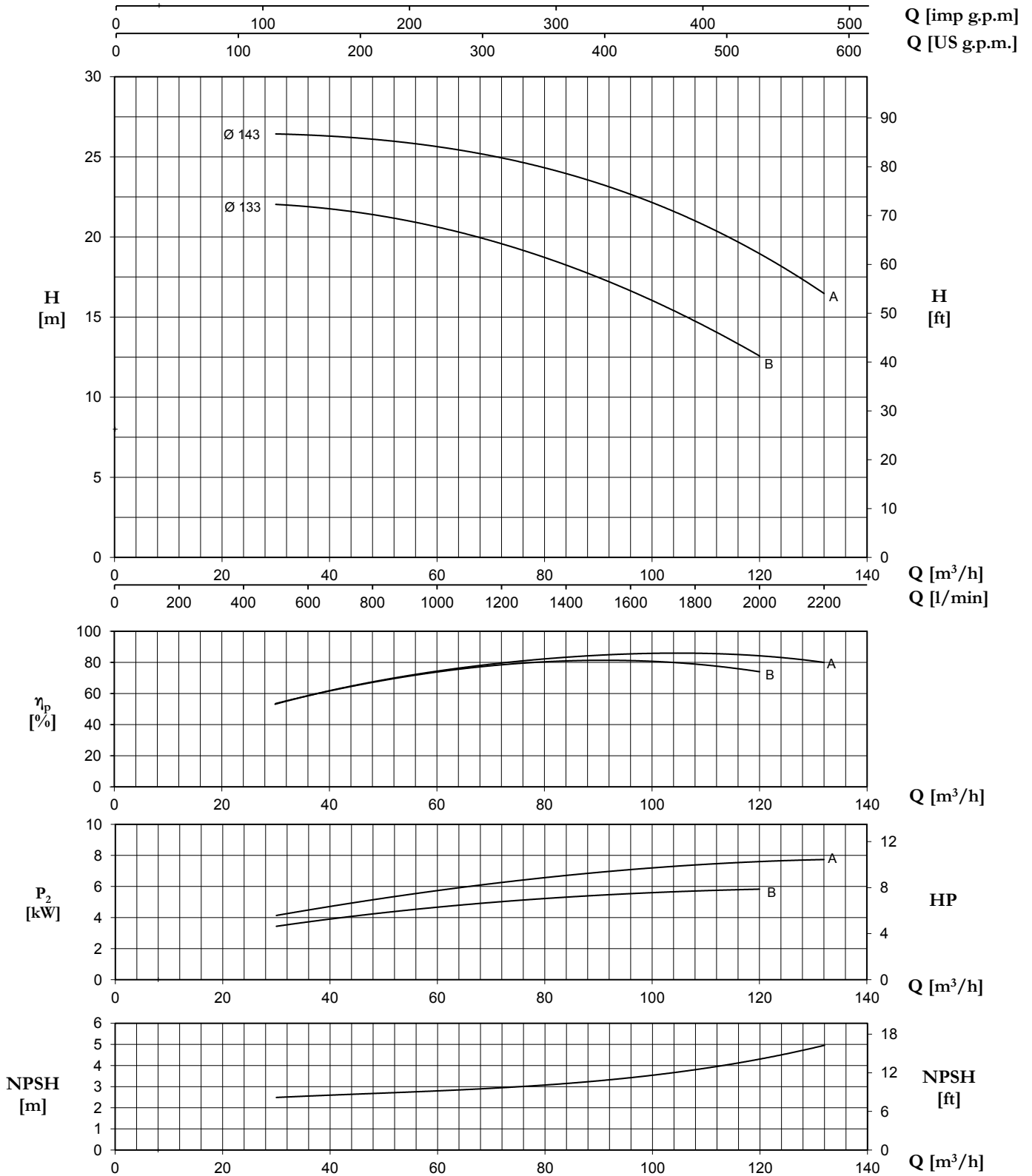

Tolerance: ISO 9906:2012 - Grade 3B

TYPE	Nominal Power (kW)	Motor Size	Q (m³/h - l/min)																
			0	30	33	36	39	42	48	54	60	66	72	78	84	96	108	120	132
			0	500	550	600	650	700	800	900	1000	1100	1200	1300	1400	1600	1800	2000	2200
			H (m) / pump input power (kW)																
65-125B	5,5	132S	20,9 2,3	22,0 3,6	22,0 3,7	21,9 3,8	21,8 3,9	21,7 4,0	21,4 4,3	21,0 4,6	20,6 4,7	20,1 5,0	19,6 5,1	19,0 5,2	18,3 5,4	16,6 5,4	14,7 5,8	12,6 5,9	
65-125A	7,5	132S	25,4 2,8	26,4 4,1	26,4 4,3	26,4 4,6	26,3 4,7	26,3 4,9	26,1 5,2	25,9 5,5	25,6 5,9	25,3 6,1	24,9 6,4	24,5 6,7	24,0 6,9	22,7 7,2	21,0 7,5	18,9 7,7	16,5 7,8

65-160

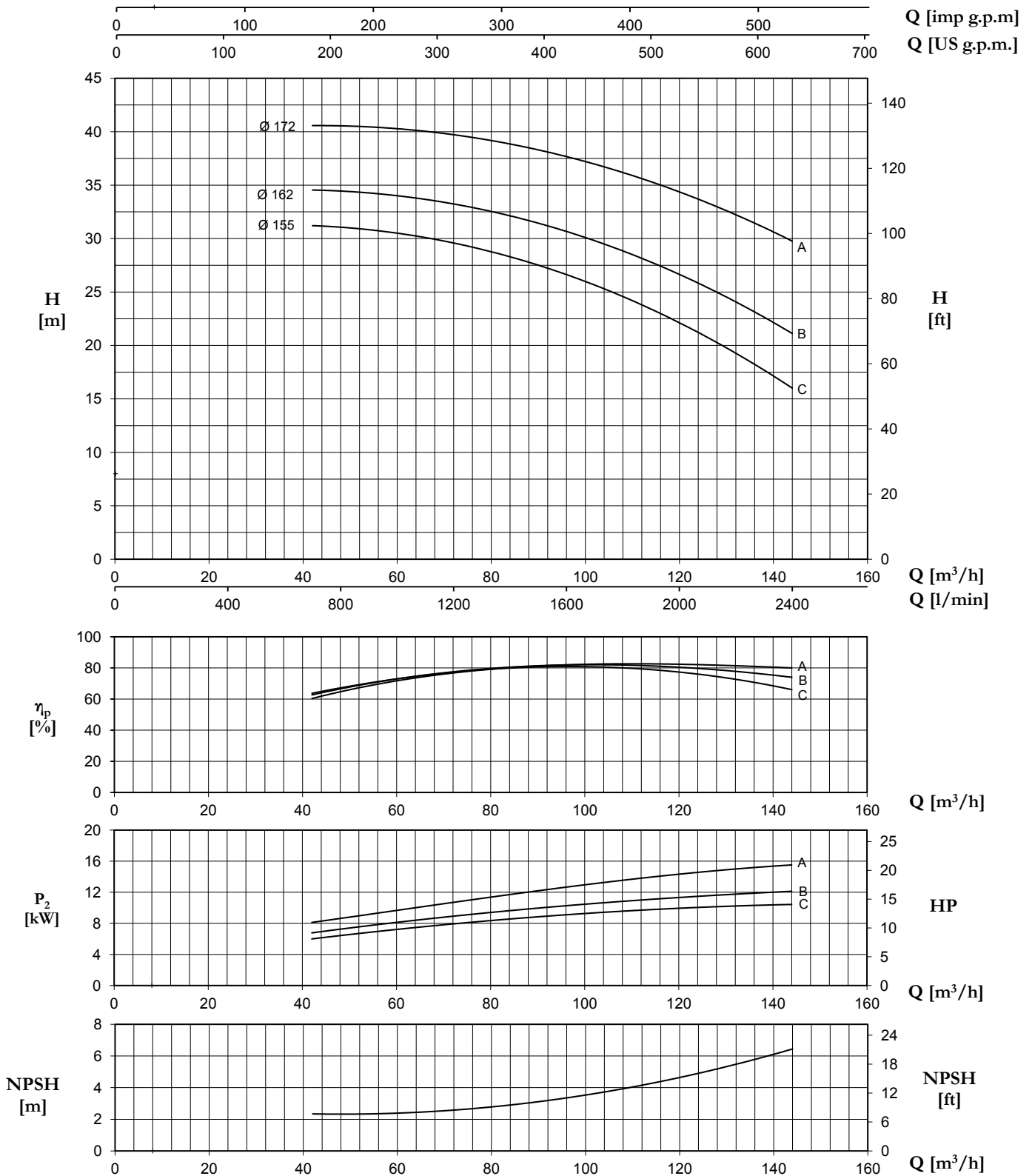

Tolerance: ISO 9906:2012 - Grade 3B

TYPE	Nominal Power (kW)	Motor Size	Q (m³/h - l/min)											
			0	42	48	60	72	78	84	108	132	144		
			0	700	800	1000	1200	1300	1400	1800	2200	2400		
H (m) / pump input power (kW)														
65-160C	11	160M	29,8 3,09	31,2 6,00	31,1 6,42	30,5 7,21	29,6 7,93	29,0 8,25	28,3 8,55	24,6 9,56	19,3 10,23	16,0 10,43		
65-160B	11	160M	33,0 3,49	34,6 6,79	34,4 7,24	34,0 8,09	33,3 8,91	32,8 9,29	32,1 9,63	28,8 10,85	24,1 11,70	21,1 12,16		
65-160A	15	160M	39,2 4,65	40,6 8,10	40,6 8,64	40,2 9,66	39,7 10,68	39,4 11,19	38,9 11,69	36,2 13,55	32,2 14,93	29,8 15,55		

MA/MAT - MAX EN 733 ~ 2900 r.p.m.

65-200

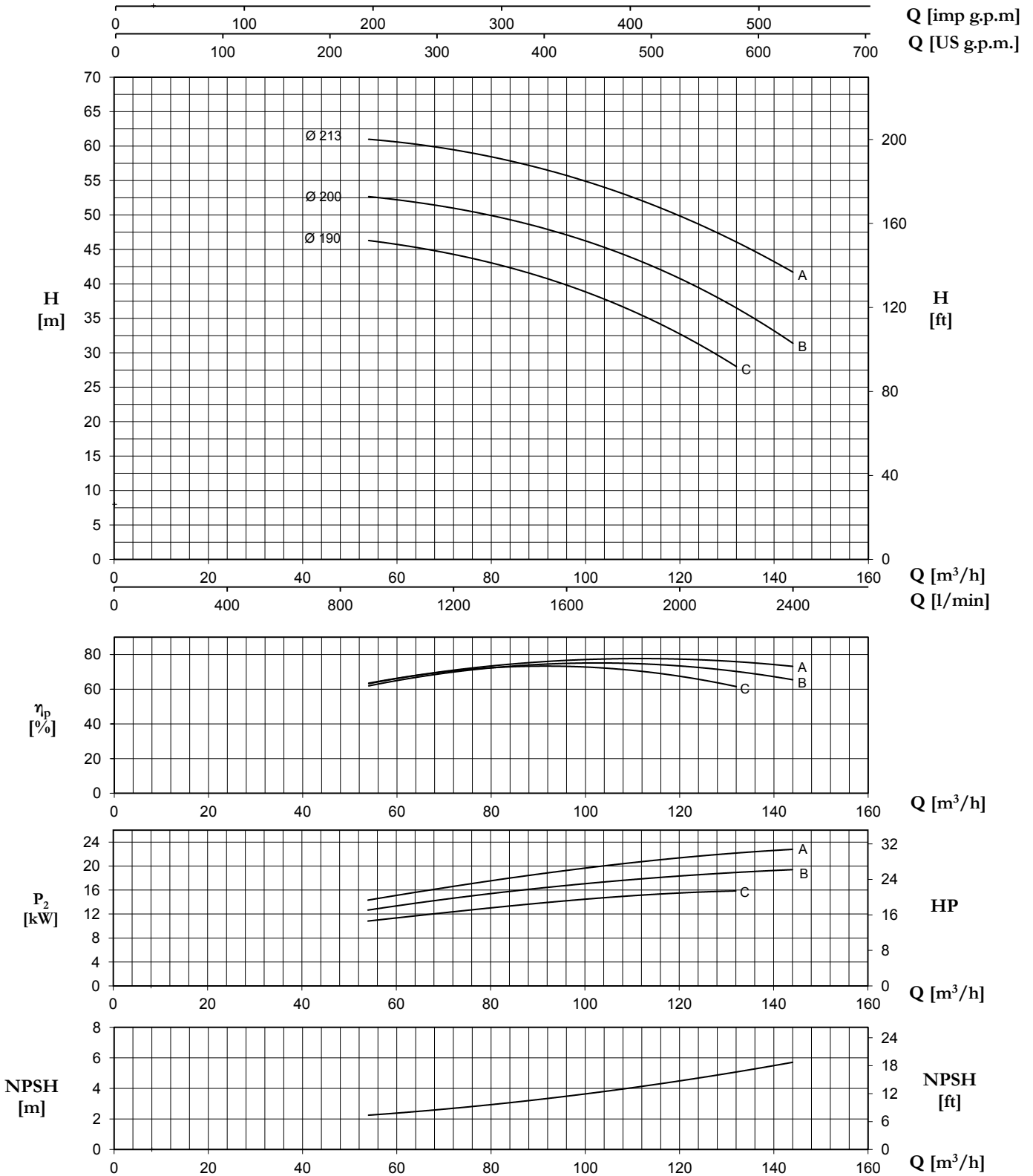

Tolerance: ISO 9906:2012 - Grade 3B

TYPE	Nominal Power (kW)	Motor Size	Q (m ³ /h - l/min)											
			0	54	60	66	72	78	84	96	108	120	132	144
			0	900	1000	1100	1200	1300	1400	1600	1800	2000	2200	2400
H (m) / pump input power (kW)														
65-200C	15	160M	45,3 4,9	46,3 10,8	45,7 11,3	45,1 11,8	44,3 12,3	43,4 12,9	42,3 13,3	39,8 13,8	36,7 14,9	32,7 15,4	28,0 15,8	
65-200B	18,5	160L	51,6 5,4	52,6 11,6	52,2 12,2	51,8 13,0	51,0 13,8	50,2 14,3	49,3 15,0	47,1 16,0	44,1 16,7	40,9 17,5	36,6 18,2	31,3 18,6
65-200A	22	180M	60,2 7,6	61,0 14,9	60,6 15,4	60,1 16,2	59,5 17,1	58,7 17,9	57,8 18,8	55,8 19,8	53,1 20,9	49,8 22,0	46,1 22,8	41,7 23,3

MA/MAT - MAX EN 733 ~ 2900 r.p.m.

65-250

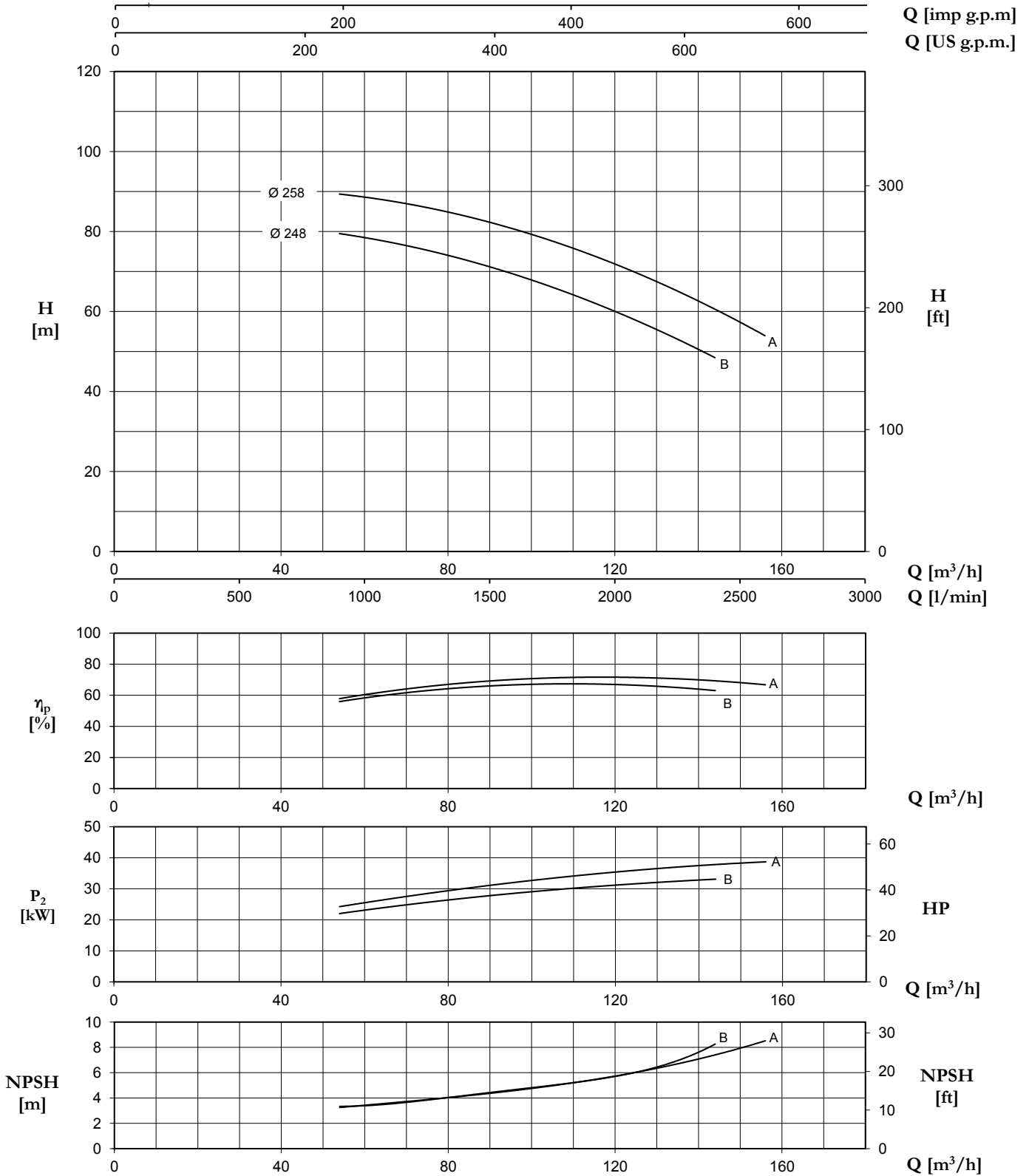

Tolerance: ISO 9906:2012 - Grade 3B

TYPE	Nominal Power (kW)	Motor Size	Q (m³/h - l/min)																								
			0	54	60	66	72	78	84	96	108	120	132	144	156												
			0	900	1000	1100	1200	1300	1400	1600	1800	2000	2200	2400	2600												
			H (m) / pump input power (kW)																								
65-250B	30	200L	81,0	79,5	78,5	77,3	76,0	74,5	73,0	69,3	65,0	60,0	54,5	48,5	10,71	22,03	23,12	24,17	25,16	26,08	28,60	30,01	31,18	32,16	33,14		
65-250A	37	200L	90,0	89,5	88,5	87,5	86,5	85,5	84,0	80,5	76,5	72,0	66,5	60,5	12,09	24,25	25,52	26,73	27,90	29,05	30,15	32,07	33,78	35,41	36,76	37,84	38,67

MA EN 733 (only MA version) ~ 2900 r.p.m.

65-315

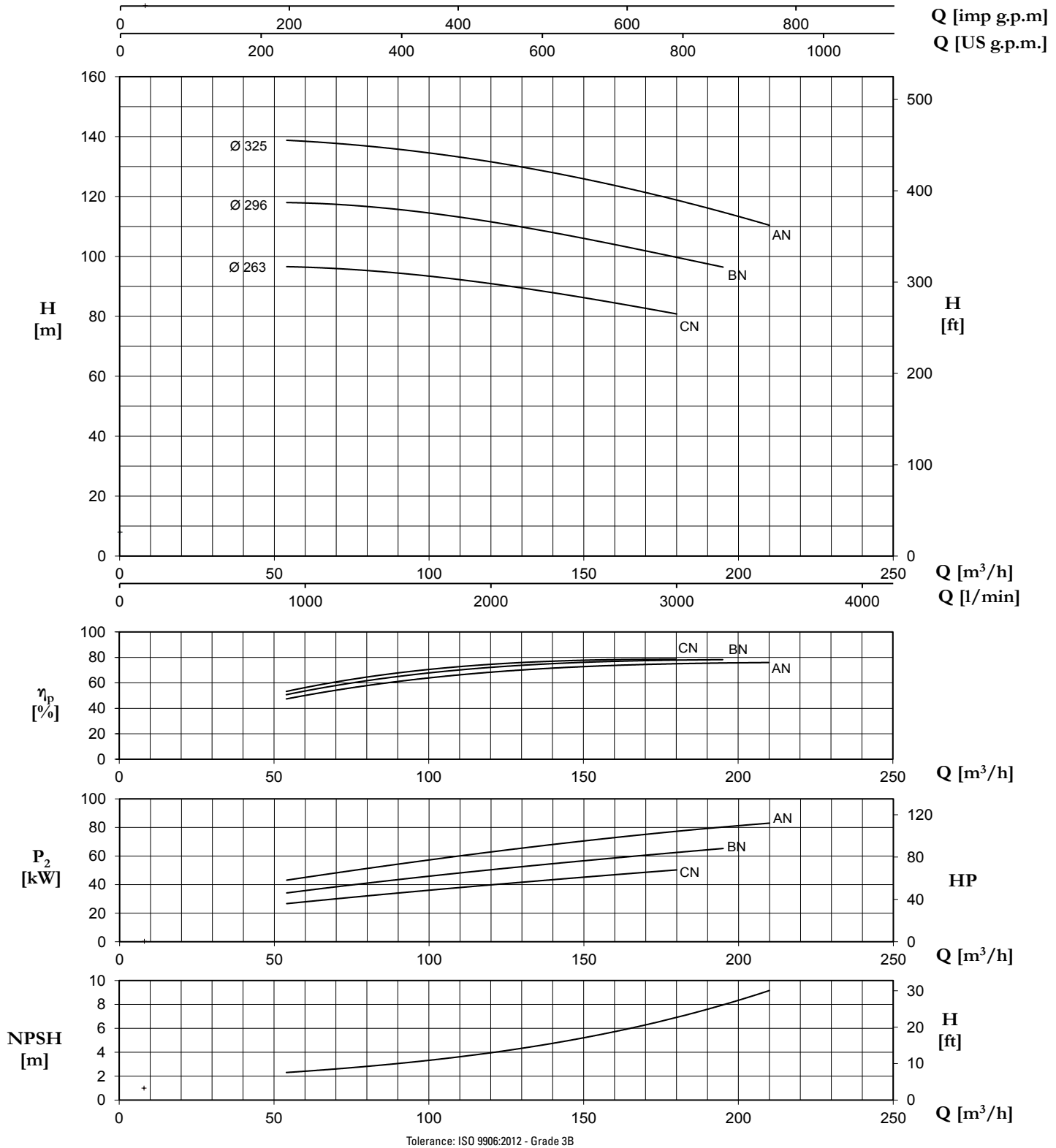

TYPE	Nominal Power (kW)	Motor Size	Q (m³/h - l/min)										
			0	54	66	78	96	120	144	180	195	210	
			0	900	1100	1300	1600	2000	2400	3000	3250	3500	
H (m) / pump input power (kW)													
65-315CN	55	250M	93,9 15,58	96,5 26,64	96,3 29,26	95,6 31,67	93,8 35,28	90,7 39,76	87,5 44,18	80,8 50,27			
65-315BN	75	280S	116,5 21,16	117,9 34,28	117,7 37,35	117,0 40,26	114,9 45,05	111,4 50,51	107,2 55,48	99,9 62,26	96,3 65,43		
65-315AN	90	280M	138,2 26,69	138,8 43,17	138,1 46,88	137,0 50,67	135,0 56,09	131,7 62,82	127,0 69,20	118,8 77,32	114,8 80,16	110,4 83,11	

MA/MAT - MAX EN 733 ~ 2900 r.p.m.

80-160

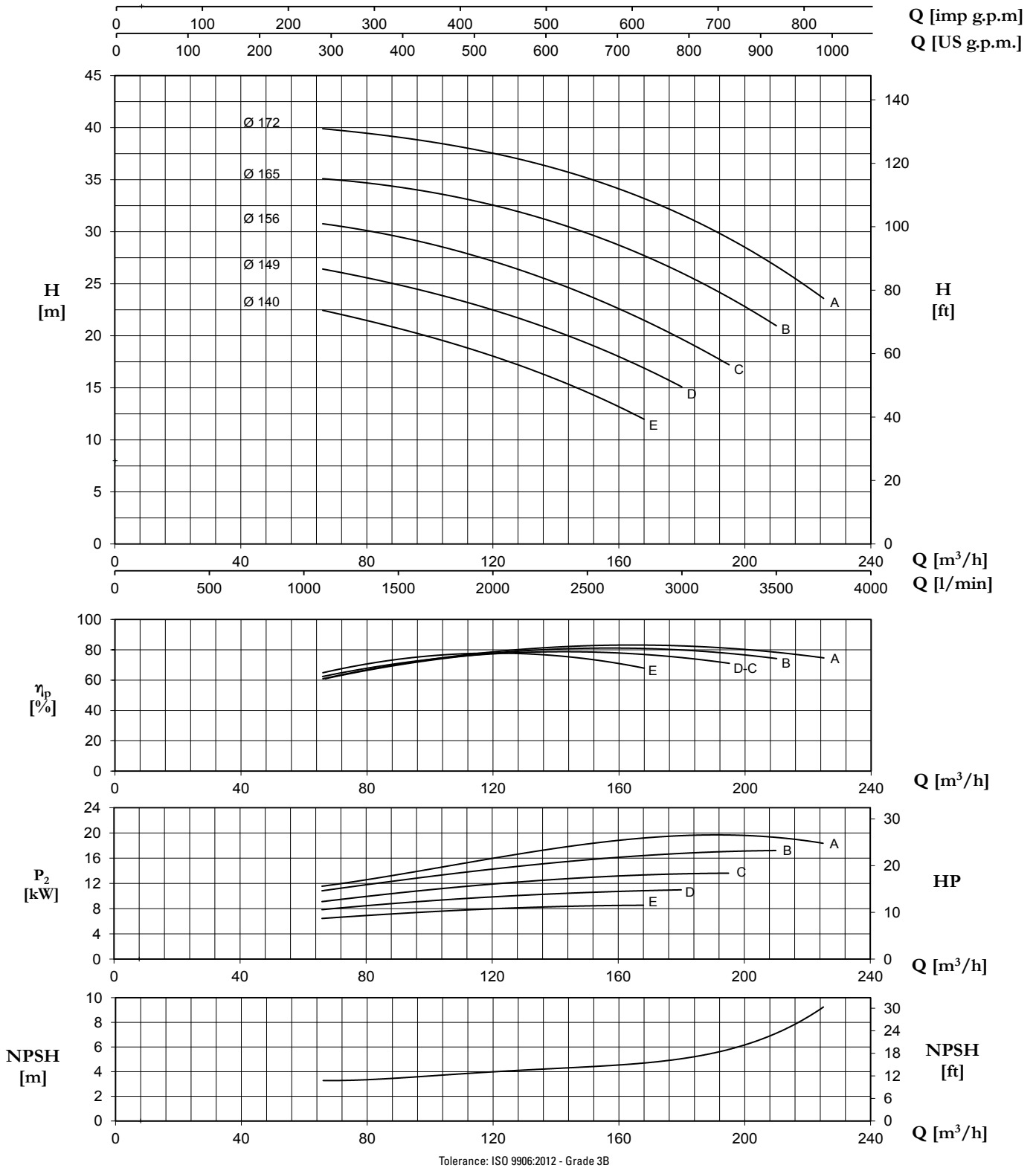

TYPE	Nominal Power (kW)	Motor Size	Q (m³/h - l/min)											
			0	78	96	108	120	144	168	180	195	210	225	
			0	1300	1600	1800	2000	2400	2800	3000	3250	3500	3750	
H (m) / pump input power (kW)														
80-160E	11	160M	21,4	21,6	20,2	19,2	18,0	15,4	12,0					
			3,6	6,8	7,3	7,6	8,0	8,4	8,4					
80-160D	11	160M	25,4	25,7	24,4	23,6	22,5	20,0	16,9	15,1				
			4,0	8,5	9,1	9,5	9,9	10,5	10,9	10,9				
80-160C	15	160M	29,7	30,3	29,2	28,1	27,1	24,7	21,5	19,7	17,2			
			5,2	9,7	10,7	11,1	11,7	12,7	13,3	13,5	13,5			
80-160B	18,5	160L	34,0	34,8	34,0	33,3	32,5	30,5	27,8	26,0	23,6	21,0		
			5,7	10,8	11,6	12,6	13,3	14,6	15,4	15,8	16,0	16,3		
80-160A	22	180M	38,8	39,6	38,9	38,2	37,5	35,7	33,2	31,6	29,4	26,8	23,5	
			7,3	13,3	14,6	15,6	16,5	18,0	19,3	19,8	20,3	21,0	20,1	

MA/MAT - MAX EN 733 ~ 2900 r.p.m.

80-200

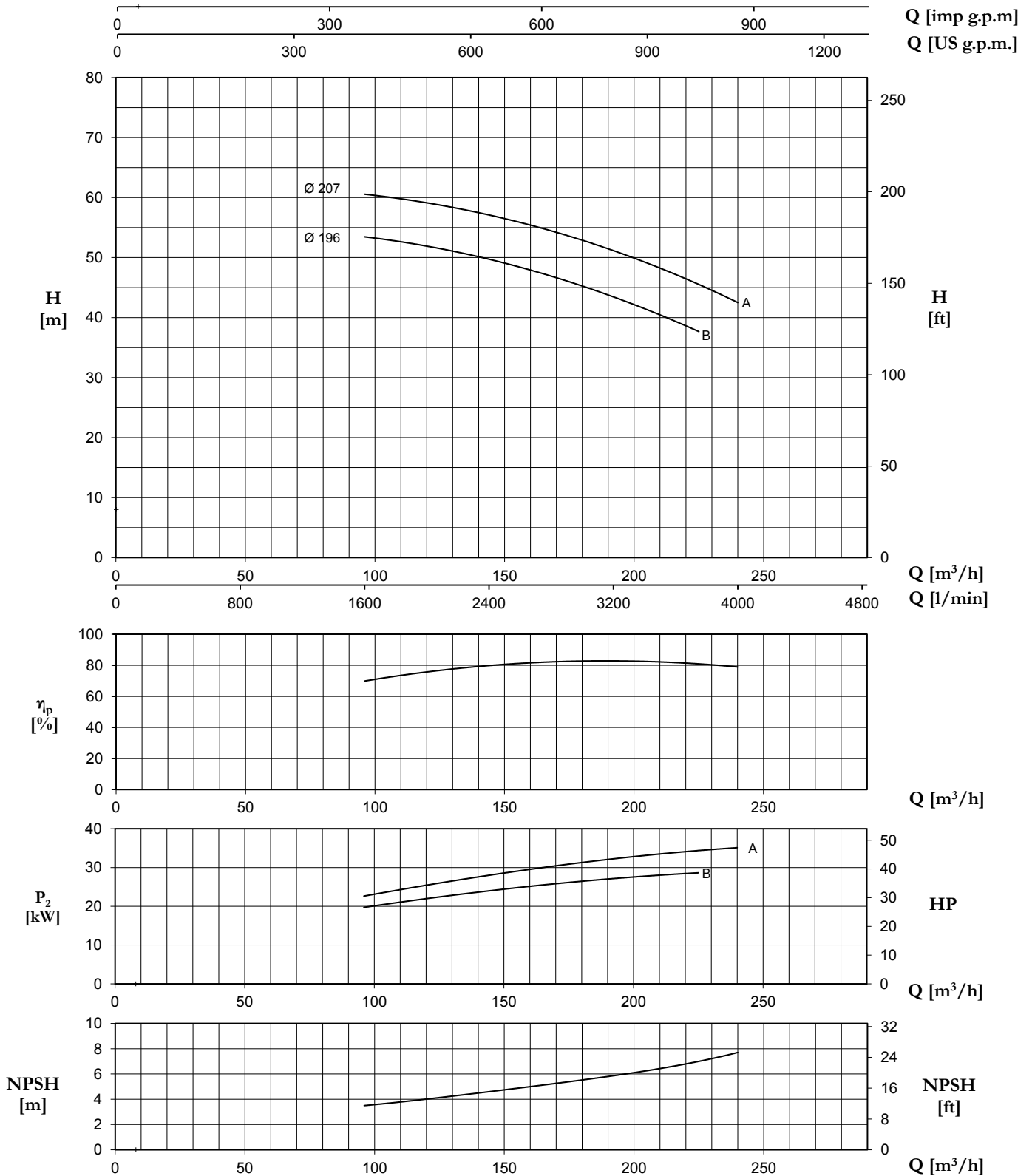

Tolerance: ISO 9906:2012 - Grade 3B

TYPE	Nominal Power (kW)	Motor Size	Q (m³/h - l/min)									
			0	96	120	132	156	168	180	210	225	240
			0	1600	2000	2200	2600	2800	3000	3500	3750	4000
H (m) / pump input power (kW)												
80-200B	30	200L	50,1 9,20	53,5 19,70	51,8 21,99	50,9 23,00	48,5 24,85	46,9 25,69	45,2 26,46	40,4 28,05	37,7 28,62	
80-200A	37	200L	56,7 10,58	60,6 22,62	59,1 25,46	58,1 26,77	56,0 29,07	54,4 30,29	52,7 31,35	48,3 33,46	45,6 34,35	42,4 35,12

MA/MAT - MAX EN 733 ~ 2900 r.p.m.

80-250

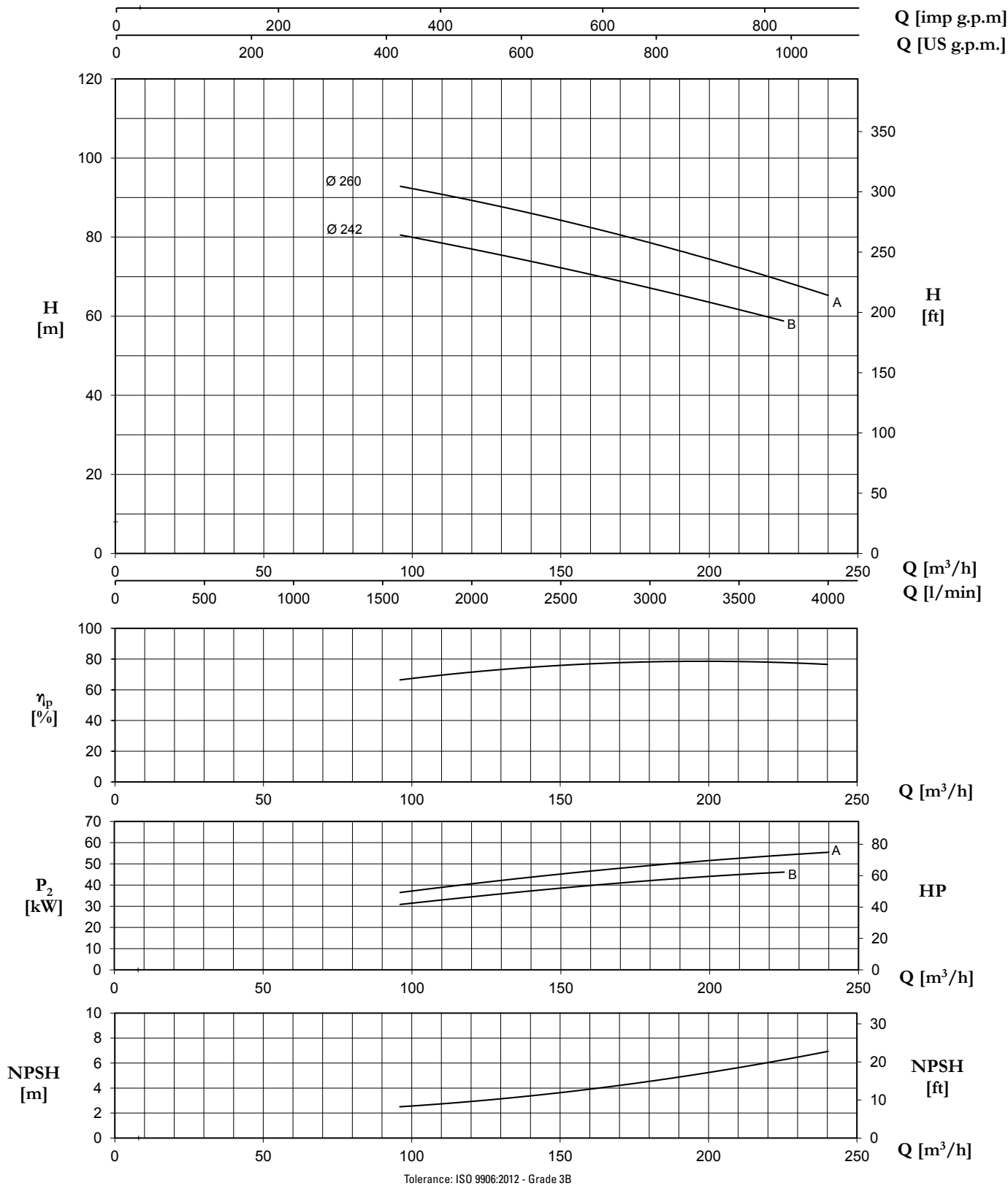

TYPE	Nominal Power (kW)	Motor Size	Q (m³/h - l/min)											
			0	96	108	120	144	168	180	195	210	225	240	
			0	1600	1800	2000	2400	2800	3000	3250	3500	3750	4000	
			H (m) / pump input power (kW)											
80-250 B	45	225M	77,2	80,0	79,0	77,5	73,1	69,0	67,0	64,5	61,8	58,8		
			14,01	30,93	32,60	34,34	37,86	40,78	42,10	43,60	44,94	46,15		
80-250 A	55	250M	90,0	92,8	91,1	89,3	85,4	80,7	78,5	75,7	72,4	68,8	65,2	
			16,74	36,56	38,57	40,54	44,31	47,81	49,29	50,92	52,59	54,18	55,50	

MA EN 733 (only MA version) ~ 2900 r.p.m.

80-315

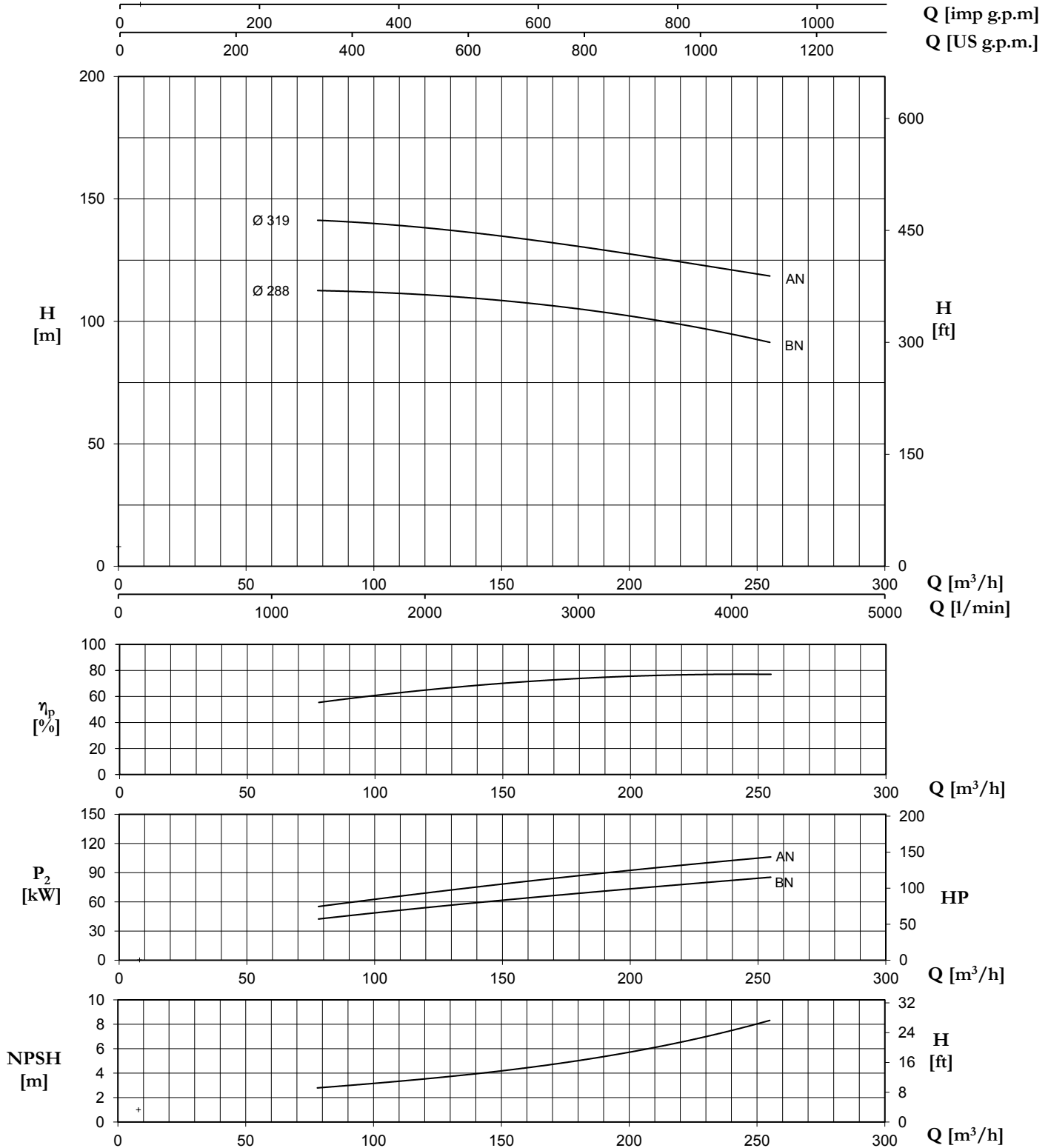

Tolerance: ISO 9906:2012 - Grade 3B

TYPE	Nominal Power (kW)	Motor Size	Q (m³/h - l/min)									
			0	78	96	120	144	168	195	225	255	
			0	1300	1600	2000	2400	2800	3250	3750	4250	
H (m) / pump input power (kW)												
80-315BN	90	280M	108,0 21,85	112,4 42,35	112,2 47,49	111,1 54,13	109,1 60,24	106,4 65,95	102,7 72,14	98,3 78,97	90,8 85,17	
80-315AN	110	315M	140,5 31,92	141,4 55,48	140,2 61,13	138,1 68,78	135,5 76,96	132,5 84,36	128,7 90,23	122,5 99,35	118,5 106,15	

MA/MAT - MAX EN 733 ~ 2900 r.p.m.

100-200

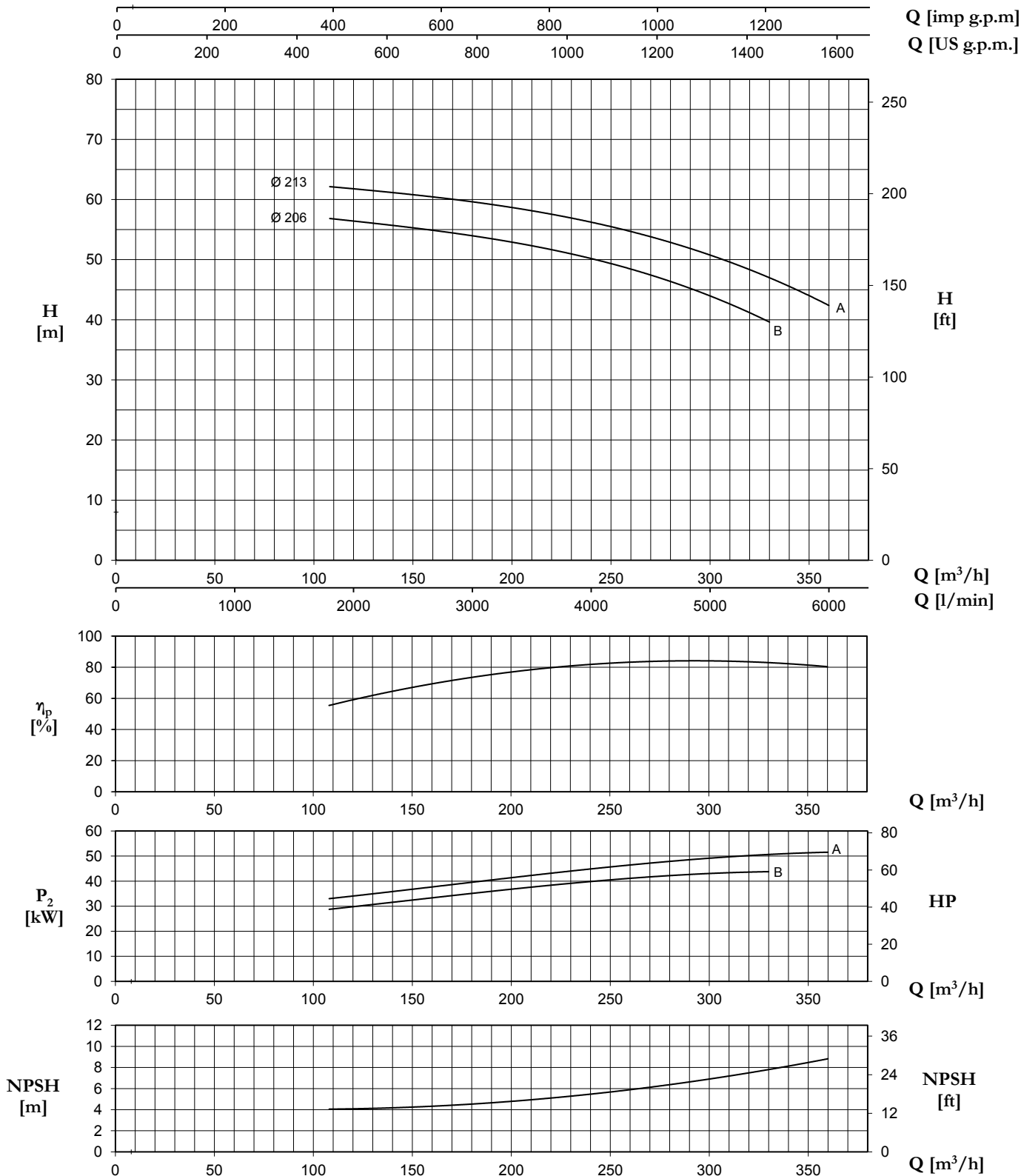

Tolerance: ISO 9906:2012 - Grade 3B

TYPE	Nominal Power (kW)	Motor Size	Q (m³/h - l/min)											
			0	108	144	168	210	225	240	270	300	330	360	
			0	1800	2400	2800	3500	3750	4000	4500	5000	5500	6000	
			H (m) / pump input power (kW)											
100-200 B	45	225M	56,1	56,8	55,6	54,5	52,2	51,4	50,4	47,5	43,8	39,7		
			21,75	28,84	31,75	33,89	37,82	38,89	39,85	41,60	42,92	43,82		
100-200 A	55	250M	61,1	62,2	61,0	59,9	58,3	57,4	56,4	53,8	50,6	46,8	42,5	
			24,57	33,04	36,18	38,39	42,23	43,60	44,97	47,28	49,05	50,53	51,62	

MA/MAT - MAX EN 733 ~ 2900 r.p.m.

100-250

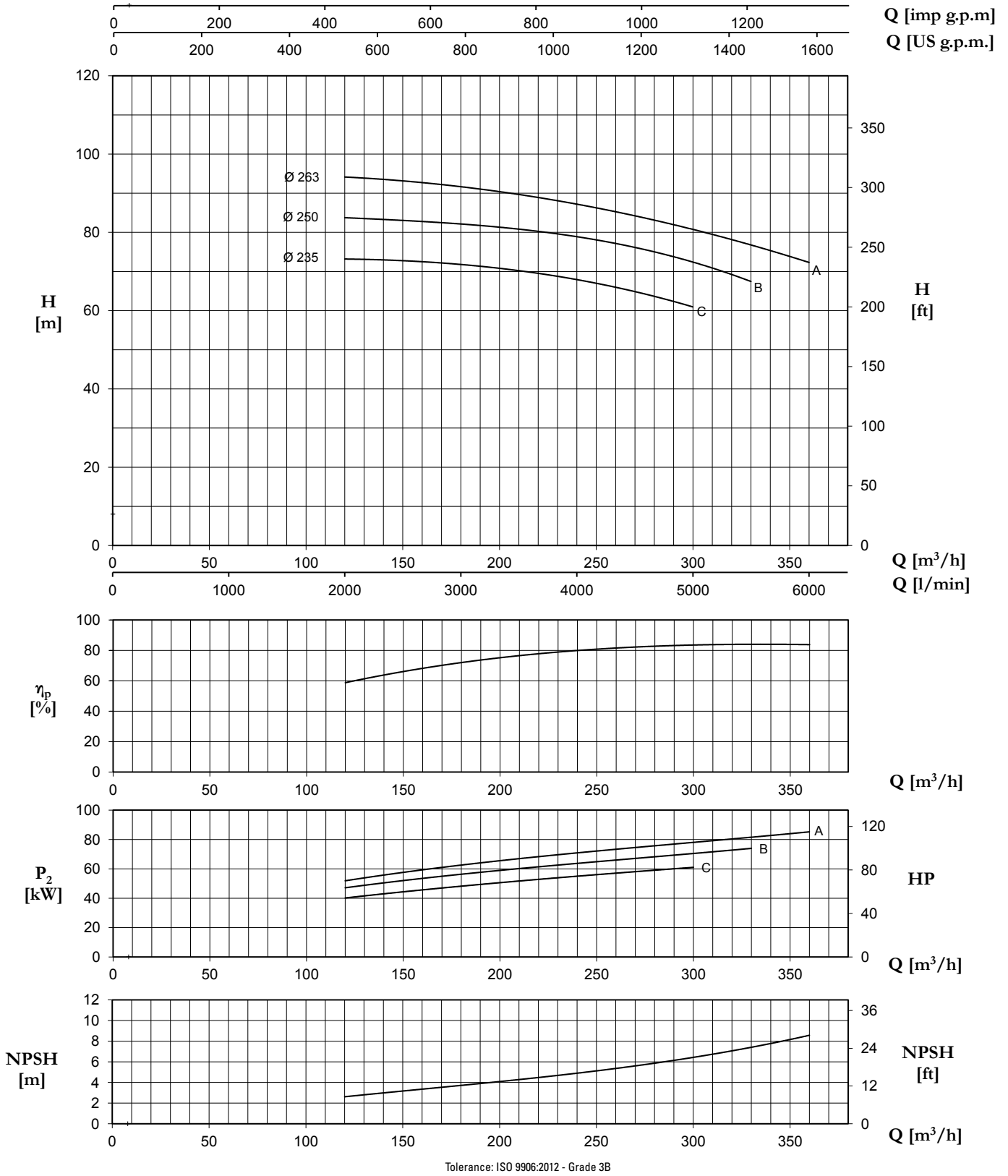

TYPE	Nominal Power (kW)	Motor Size	Q (m³/h - l/min)											
			0	120	144	168	210	225	255	270	300	330	360	
			0	2000	2400	2800	3500	3750	4250	4500	5000	5500	6000	
H (m) / pump input power (kW)														
100-250 C	55	250M	71,9	73,2	72,9	72,2	70,3	69,3	66,4	64,7	61,0			
	75	280S	24,75	40,12	43,70	46,77	51,65	53,38	56,66	58,19	60,99			
100-250 B	75	280S	83,6	83,7	83,2	82,5	80,8	80,0	77,9	76,4	72,0	67,6		
			29,69	47,10	51,01	54,76	60,26	61,86	65,17	66,93	70,91	73,78		
100-250 A	90	280M	93,5	93,9	93,4	92,4	89,9	88,8	85,7	84,0	80,4	75,8	73,2	
			32,71	51,99	56,31	60,60	66,97	68,84	72,81	74,73	78,17	81,33	85,53	

4MA/4MAT - 4MAX EN 733 ~ 1450 r.p.m.

TYPE	Nominal Power (kW)	Motor Size	Q (m³/h - l/min)																
			0	1,5	3	4,5	6	7,5	9	10,5	12	15	18	21	24	27	30	33	
			0	25	50	75	100	125	150	175	200	250	300	350	400	450	500	550	
			H (m) pump input power (kW)																
32-160C	0,37	71M	6,4 0,17	6,4 0,20	6,3 0,22	6,0 0,24	5,8 0,27	5,3 0,29	4,8 0,31	4,0 0,31	3,1 0,32								
32-160B	0,37	71M	7,4 0,19	7,4 0,22	7,3 0,25	6,9 0,28	6,6 0,30	6,1 0,32	5,5 0,34	4,8 0,35	3,8 0,37								
32-160A	0,55	80M	9,2 0,24	9,2 0,28	9,1 0,31	8,9 0,33	8,6 0,37	8,3 0,39	7,8 0,42	7,3 0,44	6,6 0,46	4,5 0,48							
32-200C	0,75	80M	11,0 0,26		10,8 0,39	10,6 0,43	10,2 0,47	9,9 0,51	9,4 0,54	8,9 0,57	8,4 0,59	6,7 0,66	4,2 0,71						
32-200B	1,1	90S	13,4 0,40		13,1 0,49	12,9 0,53	12,6 0,59	12,1 0,63	11,6 0,69	11,0 0,73	10,5 0,77	9,1 0,82	6,8 0,85						
32-200A	1,1	90S	15,9 0,44		15,7 0,53	15,5 0,57	15,3 0,66	15,0 0,71	14,5 0,77	13,8 0,82	13,2 0,88	11,7 0,98	9,5 1,04	6,8 1,10					
32-250C	1,5	90L	17,5 0,55		17,2 0,75	16,9 0,79	16,6 0,85	16,2 0,90	15,7 0,95	15,1 1,00	14,4 1,04	12,5 1,09	10,0 1,18	6,5 1,21					
32-250B	1,5	90L	20,3 0,75		20,0 0,87	19,7 0,93	19,4 1,00	19,0 1,06	18,4 1,14	17,8 1,19	17,0 1,24	15,3 1,33	12,6 1,39	8,3 1,42					
32-250A	2,2	100L	22,6 0,80		22,2 0,95	21,9 1,03	21,6 1,10	21,3 1,18	20,7 1,24	20,0 1,30	18,9 1,36	17,2 1,46	14,8 1,52	9,1 1,55					
40-125C	0,37	71M	4,6 0,17			4,8 0,20	4,7 0,21	4,6 0,23	4,5 0,25	4,4 0,26	4,2 0,28	3,8 0,29	3,2 0,31	2,4 0,32					
40-125B	0,37	71M	5,5 0,19			5,6 0,23	5,6 0,25	5,5 0,27	5,4 0,29	5,3 0,30	5,1 0,32	4,7 0,35	4,1 0,36	3,4 0,37					
40-125A	0,55	80M	6,4 0,24			6,5 0,29	6,5 0,31	6,4 0,33	6,3 0,35	6,2 0,37	6,0 0,39	5,6 0,42	5,1 0,44	4,4 0,46	3,6 0,48				
40-160B	0,55	80M	7,7 0,22			7,8 0,31	7,9 0,36	7,7 0,39	7,5 0,42	7,3 0,44	7,1 0,46	6,4 0,48	5,2 0,50	4,0 0,51	2,7 0,52				
40-160A	0,75	80M	8,9 0,23			9,0 0,35	9,1 0,39	9,0 0,42	8,8 0,46	8,6 0,48	8,4 0,50	7,6 0,54	6,7 0,58	5,7 0,60	4,3 0,61				
40-200B	1,1	90S	11,7 0,38			11,8 0,54	11,7 0,58	11,5 0,62	11,2 0,67	10,9 0,71	10,9 0,78	10,0 0,81	8,9 0,85	7,3 0,87					
40-200A	1,1	90S	14,5 0,40			14,6 0,68	14,5 0,77	14,3 0,79	14,1 0,84	13,9 0,88	13,0 0,97	12,0 1,05	10,7 1,13	9,2 1,19					
40-250C	1,5	90L	15,7 0,61						15,2 0,93	15,0 0,98	14,7 1,04	14,0 1,14	12,8 1,22	11,1 1,32	9,1 1,38	6,6 1,45			
40-250B	2,2	100L	18,3 0,73						18,2 1,13	17,9 1,19	17,7 1,24	17,1 1,39	16,2 1,51	14,9 1,62	12,9 1,73	10,7 1,80	8,2 1,91		
40-250A	2,2	100L	21,6 0,93						21,5 1,38	21,3 1,46	21,1 1,54	20,5 1,68	19,7 1,82	18,6 1,96	17,1 2,08	15,0 2,19	12,3 2,30	9,5 2,41	
50-125B	0,55	80M	5,5 0,16						5,7 0,24	5,7 0,26	5,6 0,29	5,5 0,34	5,3 0,39	5,1 0,42	4,9 0,46	4,6 0,46	4,3 0,48	3,8 0,49	
50-125A	0,75	80M	6,4 0,24						6,6 0,39	6,6 0,41	6,5 0,43	6,5 0,46	6,3 0,49	6,2 0,53	6,0 0,57	5,7 0,61	5,4 0,64	5,0 0,66	
50-160B	0,75	80M	7,9 0,23						8,0 0,43	7,9 0,45	7,8 0,47	7,7 0,51	7,3 0,56	6,9 0,60	6,4 0,63	5,9 0,65	5,3 0,66	4,7 0,67	
50-160A	1,1	90S	9,4 0,34						9,4 0,55	9,4 0,57	9,3 0,59	9,2 0,65	9,0 0,72	8,7 0,77	8,3 0,80	7,8 0,82	7,2 0,84	6,7 0,86	
50-200C	1,1	90S	12,0 0,39						12,0 0,63	11,8 0,68	11,7 0,72	11,2 0,79	10,7 0,83	10,0 0,86	9,3 0,89	8,2 0,91	7,2 0,93	6,0 0,94	
50-200B	1,5	90L	13,1 0,48						13,1 0,77	13,1 0,83	12,7 0,92	12,2 1,02	11,6 1,09	10,9 1,14	10,0 1,18	9,2 1,22	8,2 1,24		
50-200A	1,5	90L	14,8 0,54						14,7 0,87	14,5 0,92	14,4 1,03	13,9 1,14	13,4 1,22	12,7 1,28	11,9 1,32	11,0 1,36	10,0 1,40		
50-250C	2,2	100L	18,5 0,61								18,3 1,30	18,0 1,38	17,5 1,53	17,0 1,66	16,5 1,79	15,6 1,88	14,8 1,98	14,0 2,06	
50-250B	3	100L	19,9 0,79									19,6 1,58	19,1 1,72	18,8 1,85	18,2 1,97	17,5 2,07	16,7 2,19	15,7 2,28	
50-250A	4	112M	23,0 0,90									22,7 1,84	22,5 2,07	22,2 2,21	21,8 2,42	21,1 2,60	20,4 2,78	19,5 2,95	
50-315C No EN 733	5,5	132M	24,4 1,64										24,7 2,58	24,6 2,77	24,5 2,96	24,3 3,15	24,0 3,33	24,0 3,50	
50-315B No EN 733	7,5	132M	31,3 2,35										31,4 3,54	31,4 3,78	31,3 4,01	31,3 4,24	31,2 4,47	30,9 4,68	
50-315A No EN 733	11	160M	37,5 3,06										37,2 4,39	37,2 4,65	37,1 4,92	37,0 5,18	36,9 5,45	36,7 5,72	
65-125B	0,75	80M	5,1 0,33										5,3 0,51	5,3 0,53	5,2 0,56	5,2 0,59	5,1 0,60	5,0 0,63	
65-125A	1,1	90S	6,2 0,41											6,3 0,64	6,2 0,67	6,2 0,70	6,1 0,74	6,0 0,77	
65-160C	1,5	90L	7,8 0,48												8,1 0,87	8,0 0,92	7,9 0,97	7,7 1,01	
65-160B	1,5	90L	8,7 0,50												8,9 0,90	8,8 0,95	8,6 0,99	8,5 1,06	
65-160A	2,2	100L	9,8 0,66												9,9 1,06	9,9 1,14	9,8 1,20	9,6 1,25	
65-200C	2,2	100L	11,2 0,50													11,9 1,29	11,8 1,38	11,7 1,48	
65-200B	3	100L	12,3 0,69													13,1 1,45	13,0 1,51	12,8 1,61	
65-200A	3	100L	14,0 1,12													14,8 1,74	14,7 1,82	14,6 1,92	
65-250B	4	112M	20,6 1,42													21,0 2,87	20,8 2,98	20,4 3,18	
65-250A	5,5	132S	22,8 1,58														22,9 3,41	22,5 3,56	
65-315 CM	7,5	132M	23,0 2,05													23,5 3,38	23,5 3,55	23,4 3,70	
65-315 BM	11	160M	28,9 2,72													28,9 4,33	28,9 4,52	28,8 4,70	
65-315 AM	11	160M	34,5 3,44													34,0 5,43	33,9 5,66	33,7 5,88	

4MA/4MAT - 4MAX EN 733 ~ 1450 r.p.m.

TYPE	Nominal Power (kW)	Motor Size	Q (m³/h - l/min)																
			0	24	27	30	33	36	42	48	60	72	84	96	102	108	120	132	144
			0	400	450	500	550	600	700	800	1000	1200	1400	1600	1700	1800	2000	2200	2400
			H (m) pump input power (kW)																
80-160E	1,1	90S	5,5 0,35	5,7 0,71	5,7 0,74	5,7 0,74	5,6 0,78	5,4 0,81	5,1 0,88	4,9 0,90	4,2 0,97	3,8 1,02	2,8 1,02	2,2 1,00					
80-160D	1,5	90L	6,3 0,61		6,8 0,89	6,7 0,91	6,6 0,95	6,5 0,98	6,3 1,04	6,1 1,10	5,5 1,19	4,8 1,25	4 1,28	3,1 1,30	2,6 1,29				
80-160C	1,5	90L	7 0,67			7,4 1,04	7,3 1,08	7,3 1,12	7,1 1,18	6,8 1,25	6,4 1,35	5,7 1,42	4,9 1,47	4 1,48	3,5 1,48	3,1			
80-160B	2,2	100L	8,5 0,62				8,9 1,29	8,9 1,35	8,7 1,43	8,5 1,51	8,0 1,72	7,5 1,87	6,8 1,95	5,7 2,01	5,2 2,02	4,7 2,04	3,5 2,04		
80-160A	3	100L	9,3 1,09					9,8 1,60	9,7 1,71	9,5 1,81	9,1 2,01	8,6 2,14	7,9 2,27	7,1 2,34	6,6 2,37	6,2 2,39	5,0 2,42	3,8 2,43	
80-200B	4	112M	12,3 1,25						13,1 2,32	13,0 2,48	12,6 2,79	12,1 3,03	11,4 3,26	10,5 3,45	10,1 3,52	9,6 3,58	8,4 3,69	7,1 3,75	
80-200A	5,5	132S	13,8 1,40						14,7 2,64	14,6 2,81	14,2 3,14	13,7 3,43	13,1 3,66	12,3 3,87	11,7 3,99	11,2 4,09	10,1 4,21	8,8 4,30	7,5 4,35
80-250B	5,5	132S	18,9 1,79						19,2 3,52	19,0 3,75	18,1 4,14	17,0 4,48	15,9 4,78	14,8 5,05	14,2 5,16	13,6 5,24	12,4 5,41	11,1 5,54	
80-250A	7,5	132S	22,4 2,22						22,9 4,28	22,6 4,56	21,8 5,05	20,7 5,46	19,6 5,85	18,3 6,21	17,7 6,37	17,0 6,52	15,6 6,77	14,2 6,96	12,6 7,10
80-315B	11	160M	27,7 2,99						28,3 5,48	28,2 5,88	27,9 6,67	27,2 7,42	26,4 8,09	25,4 8,67	24,9 8,95	24,4 9,21	23,2 9,74	21,9 10,28	20,5 10,69
80-315A	15	160L	34,5 4,29						35,0 7,30	34,9 7,79	34,6 8,75	34,1 9,66	33,3 10,53	32,4 11,36	31,9 11,77	31,3 12,17	30,1 12,91	28,8 13,50	27,3 14,04
100-200B	5,5	132S	13,5 2,79							13,6 3,48	13,4 3,70	13,1 3,93	12,8 4,15	12,5 4,38	12,3 4,49	12,1 4,59	11,6 4,77	11,0 4,93	10,3 5,05
100-200A	7,5	132M	15,2 3,12							15,4 3,96	15,3 4,22	15,0 4,48	14,8 4,74	14,5 5,03	14,4 5,17	14,2 5,31	13,8 5,58	13,2 5,80	12,5 5,99
100-250E	7,5	132M	16,7 3,06								16,9 4,71	16,8 5,06	16,6 5,42	16,3 5,75	16,2 5,91	16,0 6,07	15,5 6,39	14,8 6,69	14,0 6,96
100-250D	7,5	132M	19,6 3,39								19,6 5,44	19,4 5,88	19,2 6,29	18,9 6,66	18,7 6,82	18,5 6,98	18,0 7,30	17,4 7,60	16,6 7,90
100-250A	11	160M	22,6 3,96								22,3 6,17	22,1 6,67	21,8 7,15	21,4 7,59	21,2 7,80	21,0 8,00	20,5 8,37	19,9 8,71	19,1 9,04
100-315B	15	160L	31,8 4,74									31,4 9,27	30,6 10,05	29,8 9,67	29,4 10,05	29,0 11,42	28,2 11,10	27,3 12,54	26,3 12,27
100-315A	18,5	180M	37,1 5,63									36,5 11,03	35,7 11,94	34,9 12,80	34,4 13,21	34,0 13,60	33,1 14,33	32,2 15,01	31,2 15,69
100-400C	22	180L	42,4 6,93										40,6 14,36	39,8 15,34	39,3 15,81	38,8 16,27	37,8 17,14	36,7 17,98	35,5 18,83
100-400B	30	200L	50,3 9,32										48,7 18,20	47,9 19,51	47,5 20,14	47,0 20,75	46,0 21,93	44,9 23,04	43,8 24,07
100-400A	37	225S	58,3 11,46										56,0 21,50	55,2 23,05	54,8 23,80	54,3 24,54	53,4 25,95	52,4 27,31	51,3 28,63
125-250B	11	160M	19,6 5,41												20,2 8,04	20,0 8,22	19,7 8,56	19,2 8,80	18,8 9,30
125-250A	15	160L	23,2 6,18												24,0 9,71	23,8 9,92	23,5 10,36	23,2 10,80	22,8 11,24
125-315C	22	180L	24,1 7,23														25,8 12,72	25,7 13,39	25,5 14,05
125-315B	30	200L	31,5 9,52														33,0 16,73	33,0 17,53	32,9 18,36
125-315A	37	225S	38,6 11,88														39,6 20,51	39,5 21,40	39,2 22,29
125-400C	45	225M	46,2 13,91														47,6 24,65	47,5 25,83	47,2 27,03
125-400B	55	250M	53,4 16,79														54,5 28,74	54,3 30,15	54,1 31,55
125-400A	75	280S	58,6 18,95														59,5 31,66	59,4 33,20	59,2 34,74
150-315D	30	200L	25,7 12,22																28,3 18,44
150-315C	37	225S	29,6 14,01																32,2 21,16
150-315B	45	225M	34,0 16,47																36,3 24,33
150-315A	55	250M	39,4 18,39																41,0 27,78
150-400C	75	280S	45,6 20,78																
150-400B	75	280S	52,8 26,57																
150-400A	90	280M	59,0 29,82																

4MA/4MAT - 4MAX ~ 1450 r.p.m.

Macchine a completamento gamma, non contemplate nella normativa EN 733.

Machines complementing the existing range, not envisaged in the EN 733 standard.

Máquinas para completar la gama, no contempladas en la norma EN 733.

Machines venant compléter la gamme, non couvertes par la norme EN 733.

TYPE	Nominal Power (kW)	Motor Size	Q (m ³ /h - l/min)						H (m)	pump input power (kW)
			0	200	250	400	600	800		
			0	3333	4167	6667	10000	13333		
200-315D	37	225S	21,2	21,7	21,8	21,2	18,3	12,5		
			18,00	24,31	26,11	31,21	36,07	37,00		
200-315C	45	225M	26,6	26,6	26,4	25,9	23,1	16,9		
			21,54	29,42	31,44	37,61	43,07	45,42		
200-315B	55	250M	33,4	33,4	33,2	32,2	28,6	21,7		
			25,04	36,30	38,91	46,32	52,72	55,67		
200-315A	75	280S	36,3	35,9	35,8	35,0	31,8	24,9		
			27,90	39,49	42,13	50,07	58,82	62,36		
200-400C	90	280M	43,0	44,1	44,1	43,6	39,9	31,5		
			31,27	45,90	50,14	62,49	77,58	89,60		
200-400B	110	315S	49,5	50,8	51,0	50,6	47,2	39,5		
			40,00	54,29	58,92	73,89	91,32	105,65		
200-400A	132	315M	57,2	58,5	58,6	58,2	55,2	48,2		
			49,00	65,01	70,26	87,26	107,05	124,54		
250-315C	55	280M	26,1		25,5	25,3	24,1	22,3		
	75	280S	28,00		37,82	44,23	51,71	57,65		
250-315B	75	280S	33,2		33,0	32,7	31,8	29,6		
			43,46		54,77	61,20	68,72	74,57		
250-315A	90	280M	35,8		35,0	34,4	33,3	31,3		
			46,41		57,61	64,50	73,28	78,44		
250-400D	110	315S	38,3		39,9	39,9	39,0	36,9		
	132	315M	48,00		61,74	71,25	84,15	95,73		
250-400C	132	315M	44,0		45,8	45,9	44,9	42,7		
	160	315L	53,83		71,89	83,20	98,11	112,06		
250-400B	160	315L	50,0		51,7	51,8	51,0	49,0		
	200	315L	64,57		84,18	97,49	115,36	131,10		
250-400A	200	315L	55,7		57,4	57,5	56,5	54,5		
			70,94		91,89	106,81	127,19	145,00		

4MA/4MAT - 4MAX ~ 1450 r.p.m.

Macchine a completamento gamma, non contemplate nella normativa EN 733.
Machines complementing the existing range, not envisaged in the EN 733 standard.
 Máquinas para completar la gama, no contempladas en la norma EN 733.
Machines venant compléter la gamme, non couvertes par la norme EN 733.

Q (m³/h - l/min)									
	850	900	1100	1170	1200	1300	1400	1500	1600
	14167	15000	18333	19500	20000	21667	23333	25000	26667
H (m) pump input power (kW)									
	14,6								
	45,55								
	19,4	16,7							
	55,62	55,25							
	22,5	19,8							
	62,45	62,15							
	36,6								
	108,43								
	45,6	44,0							
	128,46	132,15							
	21,7	21,0	16,8						
	58,82	59,57	59,89						
	28,6	27,5	21,7	19,0					
	75,26	75,64	74,47	73,35					
	30,4	29,3	23,0	20,7	20,0				
	79,01	79,32	78,27	77,03	76,36				
	36,1	35,2	30,6	28,6	27,7	24,3			
	98,36	100,80	108,97	111,27	112,17	114,78			
	42,0	41,2	37,2	35,4	34,5	31,3	27,4		
	115,25	118,20	128,07	130,85	131,93	135,08	137,50		
	48,4	47,6	43,9	42,3	41,5	38,5	34,8	30,3	
	134,76	138,27	151,48	155,58	157,12	161,60	164,88	167,09	
	53,8	53,0	49,4	47,9	47,1	44,3	40,8	36,6	31,7
	149,18	153,24	168,92	173,94	175,86	181,62	186,11	189,07	190,57

4MA/4MAT - 4MAX EN 733 ~ 1450 r.p.m.

32-160

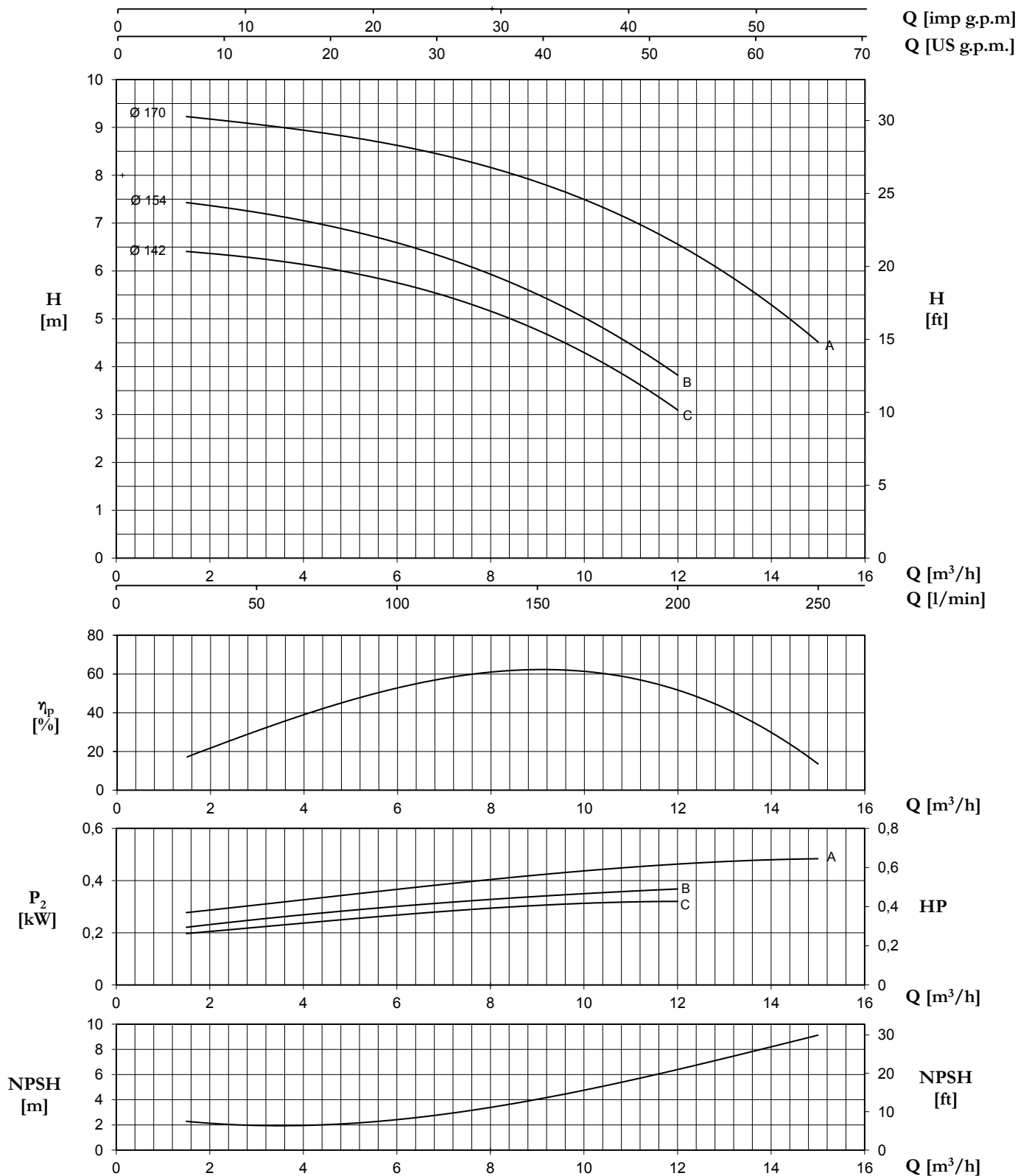

Tolerance: ISO 9906:2012 - Grade 3B

TYPE	Nominal Power (kW)	Motor Size	Q (m³/h - l/min)											
			0	1,5	3	4,5	6	7,5	9	10,5	12	15		
			0	25	50	75	100	125	150	175	200	250		
H (m) / pump input power (kW)														
32-160C	0,37	71M	6,4	6,4	6,3	6,0	5,8	5,3	4,8	4,0	3,1			
			0,17	0,20	0,22	0,24	0,27	0,29	0,31	0,31	0,32			
32-160B	0,37	71M	7,4	7,4	7,3	6,9	6,6	6,1	5,5	4,8	3,8			
			0,19	0,22	0,25	0,28	0,30	0,32	0,34	0,35	0,37			
32-160A	0,55	80M	9,2	9,2	9,1	8,9	8,6	8,3	7,8	7,3	6,6	4,5		
			0,24	0,28	0,31	0,33	0,37	0,39	0,42	0,44	0,46	0,48		

4MA/4MAT - 4MAX EN 733 ~ 1450 r.p.m.

32-200

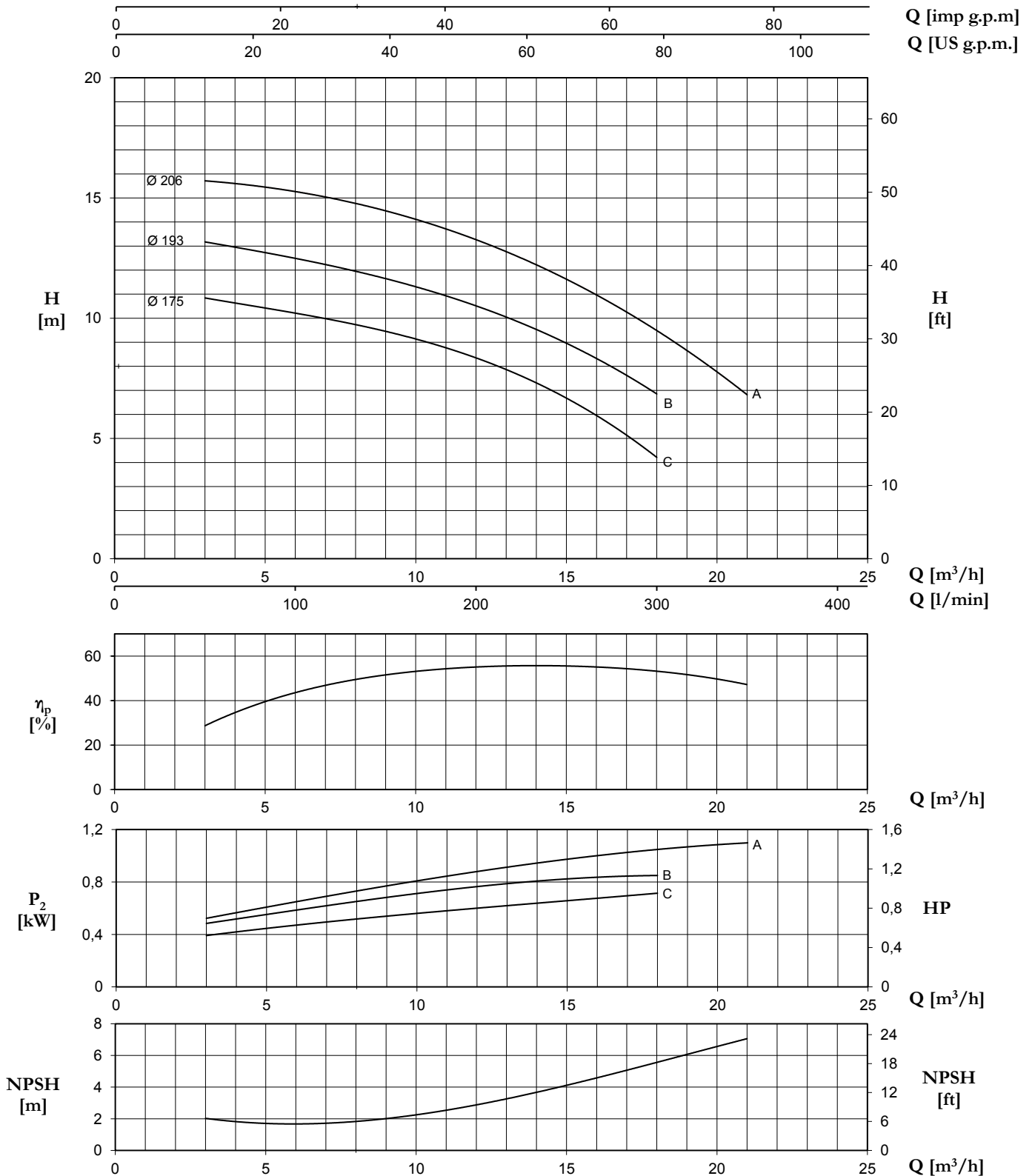

Tolerance: ISO 9906:2012 - Grade 3B

TYPE	Nominal Power (kW)	Motor Size	Q (m³/h - l/min)											
			0	3	4,5	6	7,5	9	10,5	12	15	18	21	
			0	50	75	100	125	150	175	200	250	300	350	
H (m) / pump input power (kW)														
32-200C	0,75	80M	11,0	10,8	10,6	10,2	9,9	9,4	8,9	8,4	6,7	4,2		
			0,26	0,39	0,43	0,47	0,51	0,54	0,57	0,59	0,66	0,71		
32-200B	1,1	90S	13,4	13,1	12,9	12,6	12,1	11,6	11,0	10,5	9,1	6,8		
			0,40	0,49	0,53	0,59	0,63	0,69	0,73	0,77	0,82	0,85		
32-200A	1,1	90S	15,9	15,7	15,5	15,3	15,0	14,5	13,8	13,2	11,7	9,5	6,8	
			0,44	0,53	0,57	0,66	0,71	0,77	0,82	0,88	0,98	1,04	1,10	

4MA/4MAT - 4MAX EN 733 ~ 1450 r.p.m.

32-250

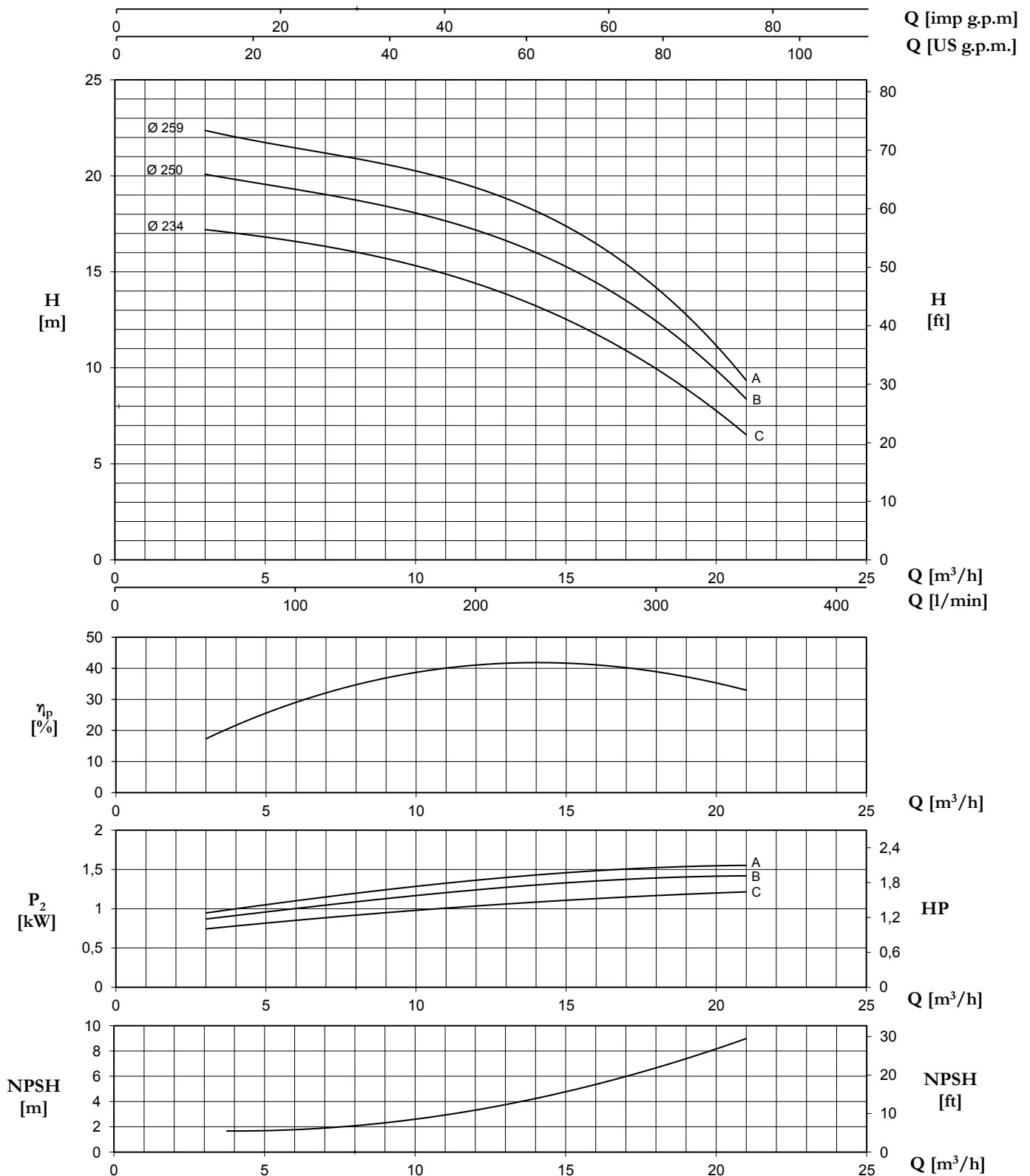

Tolerance: ISO 9906:2012 - Grade 3B

TYPE	Nominal Power (kW)	Motor Size	Q (m³/h - l/min)																					
			0	3	4,5	6	7,5	9	10,5	12	15	18	21											
			0	50	75	100	125	150	175	200	250	300	350											
H (m) / pump input power (kW)																								
32-250C	1,5	90L	17,5	17,2	16,9	16,6	16,2	15,7	15,1	14,4	12,5	10,0	6,5	0,55	0,75	0,79	0,85	0,90	0,95	1,00	1,04	1,09	1,18	1,21
32-250B	1,5	90L	20,3	20,0	19,7	19,4	19,0	18,4	17,8	17,0	15,3	12,6	8,3	0,75	0,87	0,93	1,00	1,06	1,14	1,19	1,24	1,33	1,39	1,42
32-250A	2,2	100L	22,6	22,2	21,9	21,6	21,3	20,7	20,0	18,9	17,2	14,8	9,1	0,80	0,95	1,03	1,10	1,18	1,24	1,30	1,36	1,46	1,52	1,55

4MA/4MAT - 4MAX EN 733 ~ 1450 r.p.m.

40-125

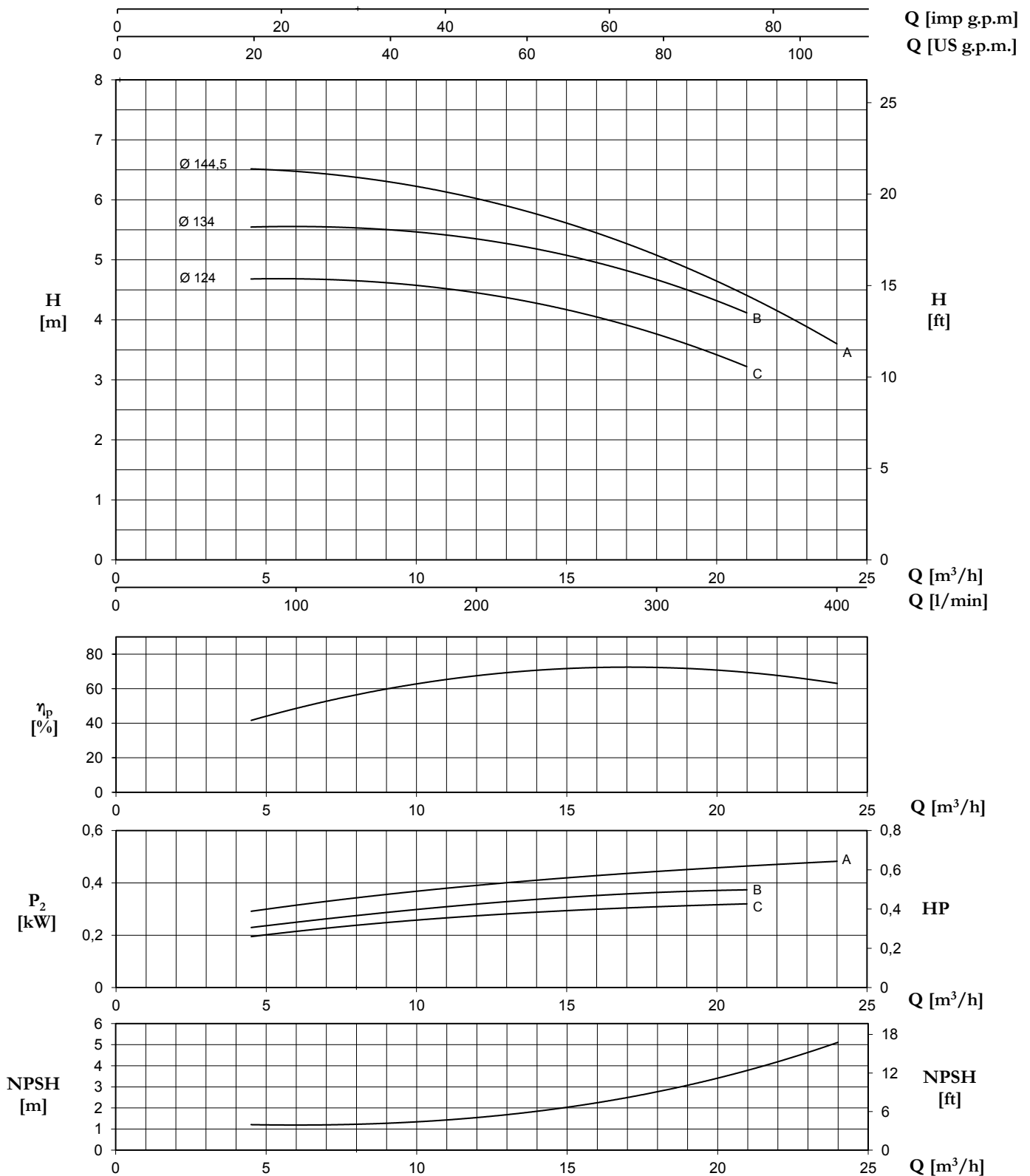

Tolerance: ISO 9906:2012 - Grade 3B

TYPE	Nominal Power (kW)	Motor Size	Q (m³/h - l/min)											
			0	4,5	6	7,5	9	10,5	12	15	18	21	24	
			0	75	100	125	150	175	200	250	300	350	400	
			H (m) / pump input power (kW)											
40-125C	0,37	71M	4,6	4,8	4,7	4,6	4,5	4,4	4,2	3,8	3,2	2,4		
			0,17	0,20	0,21	0,23	0,25	0,26	0,28	0,29	0,31	0,32		
40-125B	0,37	71M	5,5	5,6	5,6	5,5	5,4	5,3	5,1	4,7	4,1	3,4		
			0,19	0,23	0,25	0,27	0,29	0,30	0,32	0,35	0,36	0,37		
40-125A	0,55	80M	6,4	6,5	6,5	6,4	6,3	6,2	6,0	5,6	5,1	4,4	3,6	
			0,24	0,29	0,31	0,33	0,35	0,37	0,39	0,42	0,44	0,46	0,48	

4MA/4MAT - 4MAX EN 733 ~ 1450 r.p.m.

40-160

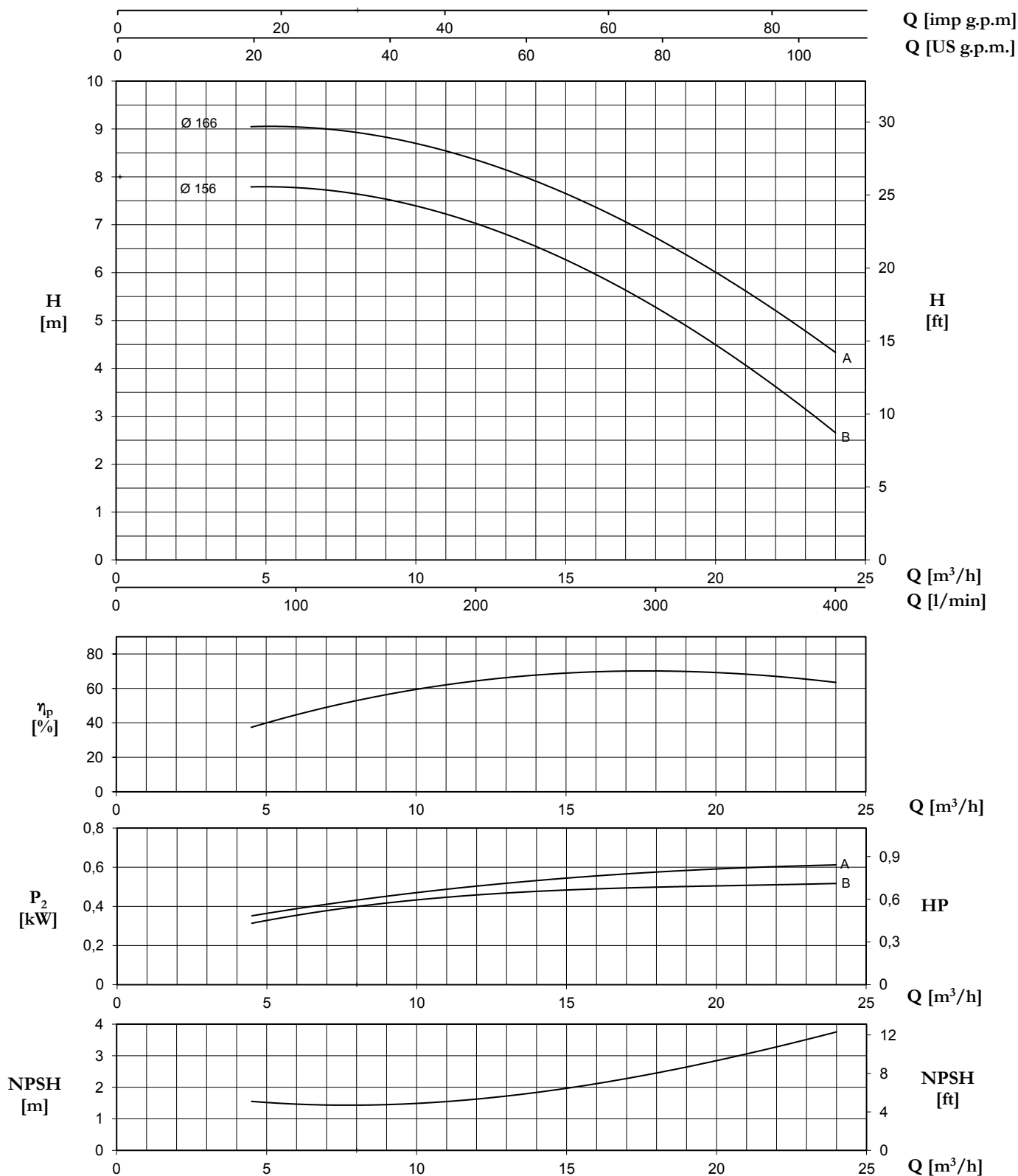

Tolerance: ISO 9906:2012 - Grade 3B

TYPE	Nominal Power (kW)	Motor Size	Q (m³/h - l/min)											
			0	4,5	6	7,5	9	10,5	12	15	18	21	24	
			0	75	100	125	150	175	200	250	300	350	400	
			H (m) / pump input power (kW)											
40-160B	0,55	80M	7,7	7,8	7,9	7,7	7,5	7,3	7,1	6,4	5,2	4,0	2,7	
			0,22	0,31	0,36	0,39	0,42	0,44	0,46	0,48	0,50	0,51	0,52	
40-160A	0,75	80M	8,9	9,0	9,1	9,0	8,8	8,6	8,4	7,6	6,7	5,7	4,3	
			0,23	0,35	0,39	0,42	0,46	0,48	0,50	0,54	0,58	0,60	0,61	

4MA/4MAT - 4MAX EN 733 ~ 1450 r.p.m.

40-200

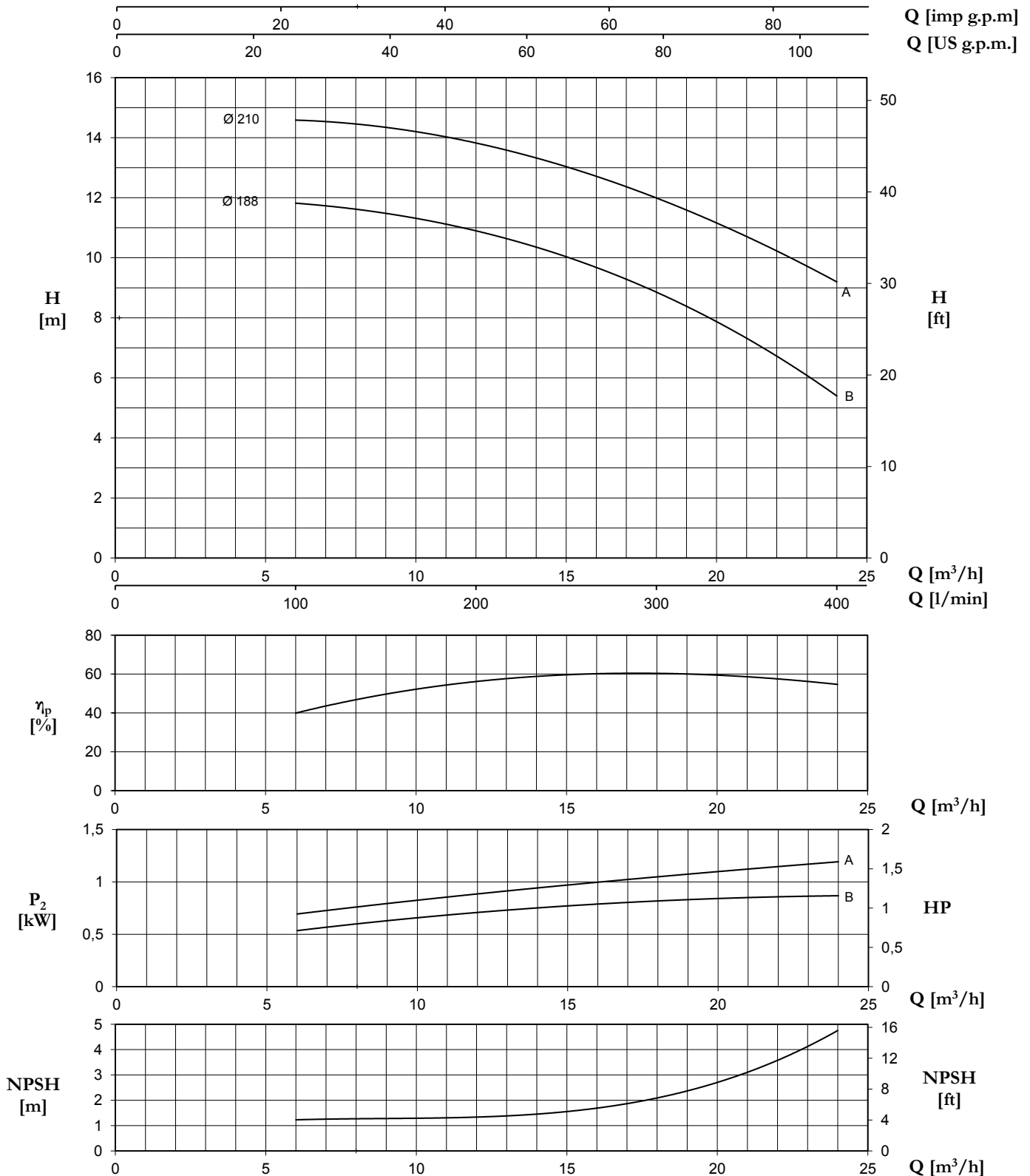

Tolerance: ISO 9906:2012 - Grade 3B

TYPE	Nominal Power (kW)	Motor Size	Q (m³/h - l/min)									
			0	6	7,5	9	10,5	12	15	18	21	24
			0	100	125	150	175	200	250	300	350	400
H (m) / pump input power (kW)												
40-200B	1,1	90S	11,7	11,8	11,7	11,5	11,2	10,9	10,0	8,9	7,3	5,4
			0,38	0,54	0,58	0,62	0,67	0,71	0,78	0,81	0,85	0,87
40-200A	1,1	90S	14,5	14,6	14,5	14,3	14,1	13,9	13,0	12,0	10,7	9,2
	1,5	90L	0,40	0,68	0,77	0,79	0,84	0,88	0,97	1,05	1,13	1,19

4MA/4MAT - 4MAX EN 733 ~ 1450 r.p.m.

40-250

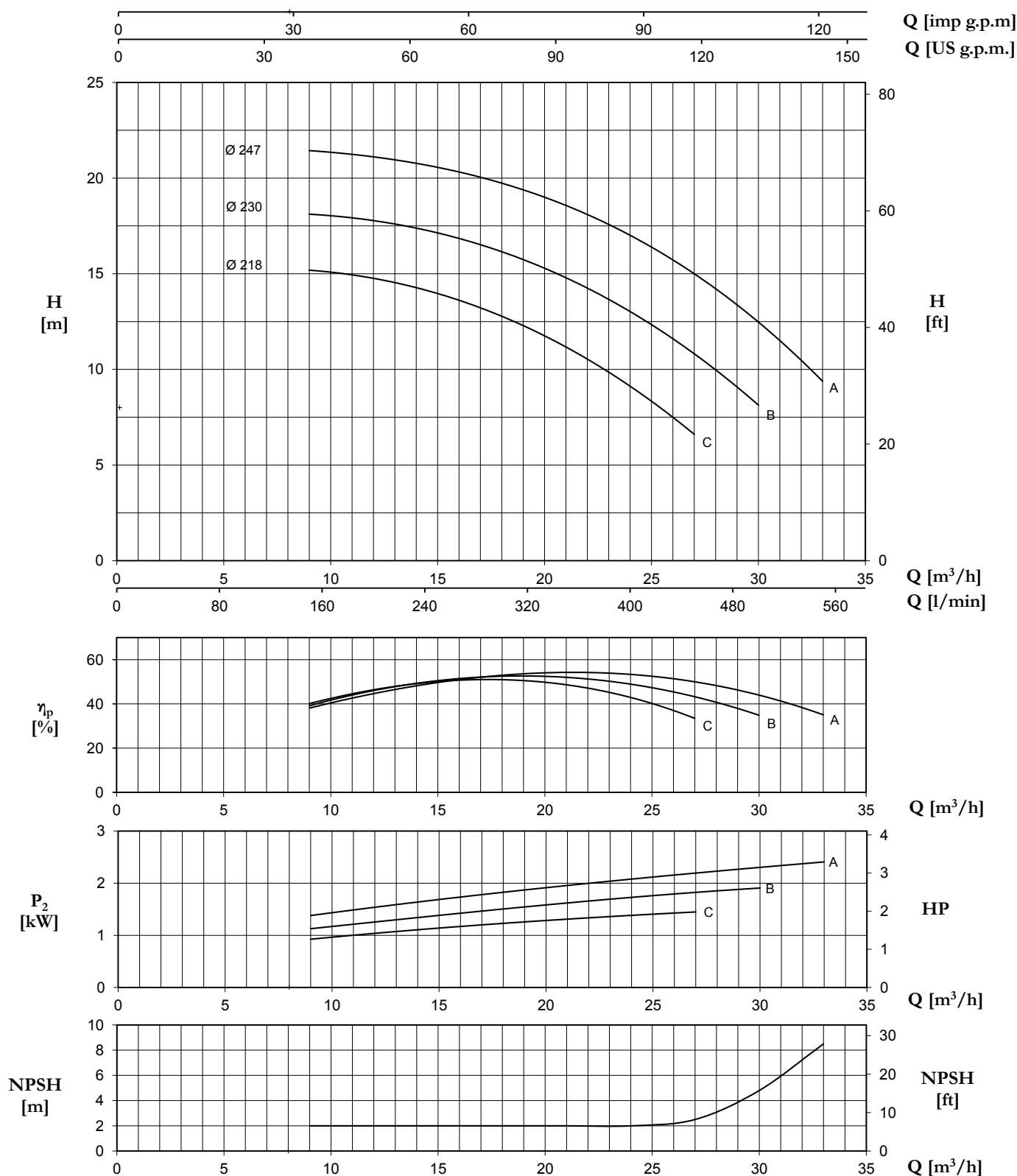

Tolerance: ISO 9906:2012 - Grade 3B

TYPE	Nominal Power (kW)	Motor Size	Q (m³/h - l/min)											
			0	9	10,5	12	15	18	21	24	27	30	33	
			0	150	175	200	250	300	350	400	450	500	550	
H (m) / pump input power (kW)														
40-250C	1,1	90S	15,7	15,2	15,0	14,7	14,0	12,8	11,1	9,1	6,6			
	1,5	90L	0,61	0,93	0,98	1,04	1,14	1,22	1,32	1,38	1,45			
40-250B	2,2	100L	18,3	18,2	17,9	17,7	17,1	16,2	14,9	12,9	10,7	8,2		
			0,73	1,13	1,19	1,24	1,39	1,51	1,62	1,73	1,82	1,91		
40-250A	2,2	100L	21,6	21,5	21,3	21,1	20,5	19,7	18,6	17,1	15,0	12,3	9,5	
	3	100L	0,93	1,38	1,46	1,54	1,68	1,82	1,96	2,08	2,19	2,30	2,41	

4MA/4MAT - 4MAX EN 733 ~ 1450 r.p.m.

50-125

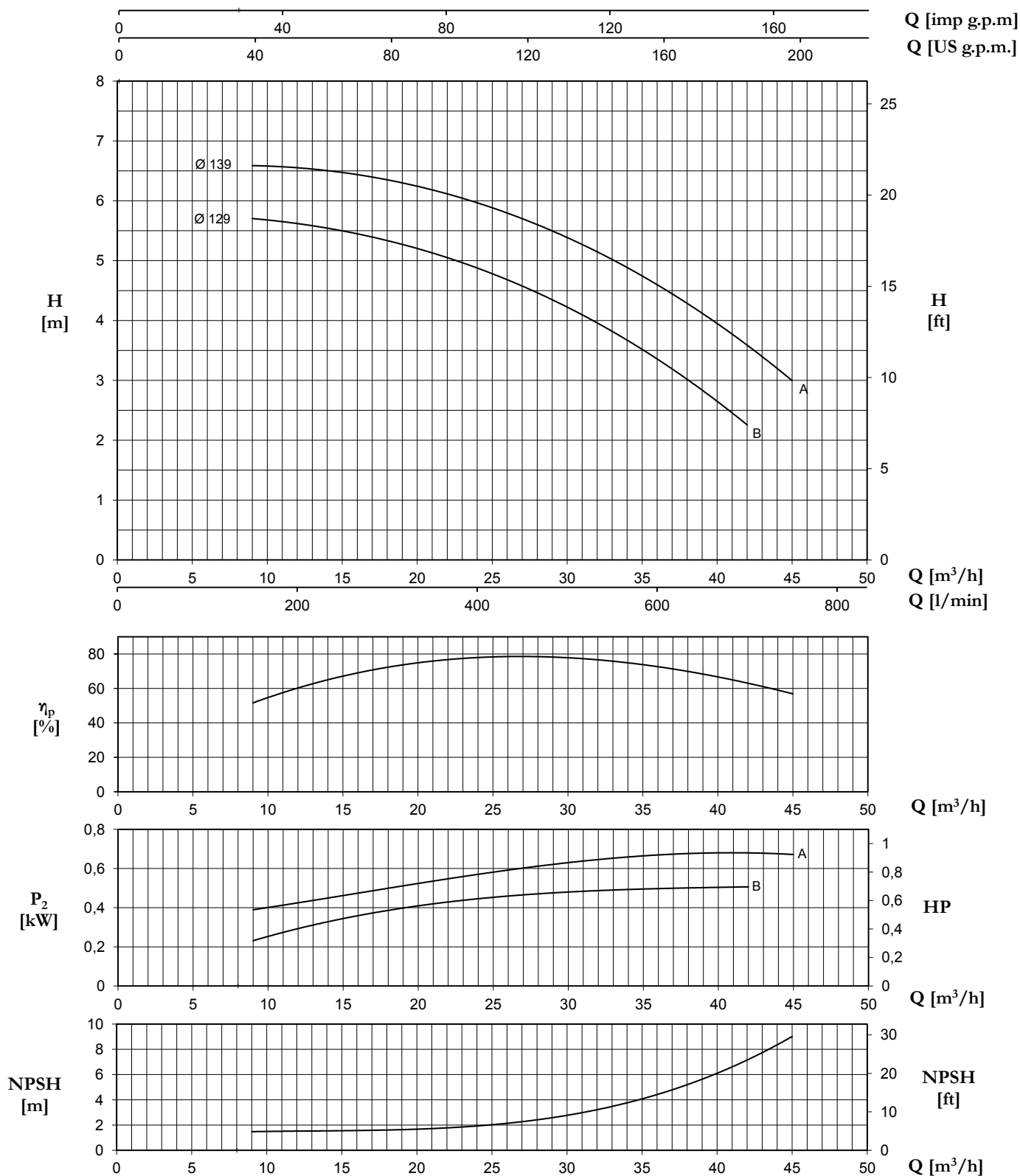

Tolerance: ISO 9906:2012 - Grade 3B

TYPE	Nominal Power (kW)	Motor Size	Q (m³/h - l/min)														
			0	9	10,5	12	15	18	21	24	27	30	33	36	39	42	45
			0	150	175	200	250	300	350	400	450	500	550	600	650	700	750
			H (m) / pump input power (kW)														
50-125B	0,55	80M	5,5 0,16	5,7 0,24	5,7 0,26	5,6 0,29	5,5 0,34	5,3 0,39	5,1 0,42	4,9 0,46	4,6 0,46	4,3 0,48	3,8 0,49	3,3 0,49	2,8 0,50	2,3 0,51	
50-125A	0,75	80M	6,4 0,24	6,6 0,39	6,6 0,41	6,5 0,43	6,5 0,46	6,3 0,49	6,2 0,53	6,0 0,57	5,7 0,61	5,4 0,64	5,0 0,66	4,6 0,66	4,1 0,67	3,6 0,67	3,0 0,68

4MA/4MAT - 4MAX EN 733 ~ 1450 r.p.m.

50-160

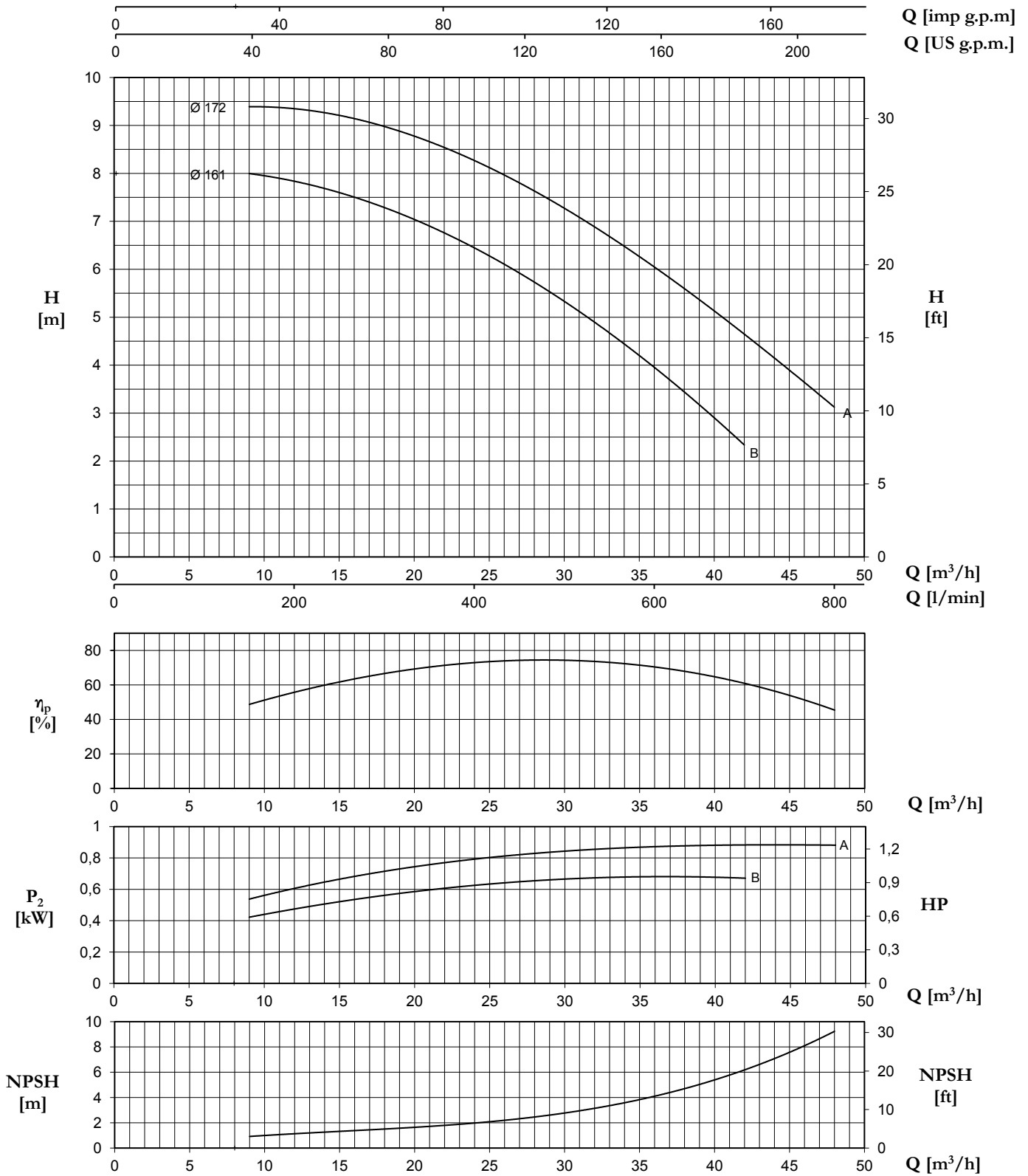

Tolerance: ISO 9906:2012 - Grade 3B

TYPE	Nominal Power (kW)	Motor Size	Q (m³/h - l/min)															
			0	9	10,5	12	15	18	21	24	27	30	33	36	39	42	45	48
			0	150	175	200	250	300	350	400	450	500	550	600	650	700	750	800
			H (m) / pump input power (kW)															
50-160B	0,75	80M	7,9	8,0	7,9	7,8	7,7	7,3	6,9	6,4	5,9	5,3	4,7	4,0	3,2	2,3		
			0,23	0,43	0,45	0,47	0,51	0,56	0,60	0,63	0,65	0,66	0,67	0,68	0,68	0,67		
50-160A	1,1	90S	9,4	9,4	9,4	9,3	9,2	9,0	8,7	8,3	7,8	7,2	6,7	6,0	5,4	4,7	3,9	3,1
			0,34	0,55	0,57	0,59	0,65	0,72	0,77	0,80	0,82	0,84	0,86	0,87	0,88	0,88	0,89	0,88

4MA/4MAT - 4MAX EN 733 ~ 1450 r.p.m.

50-200

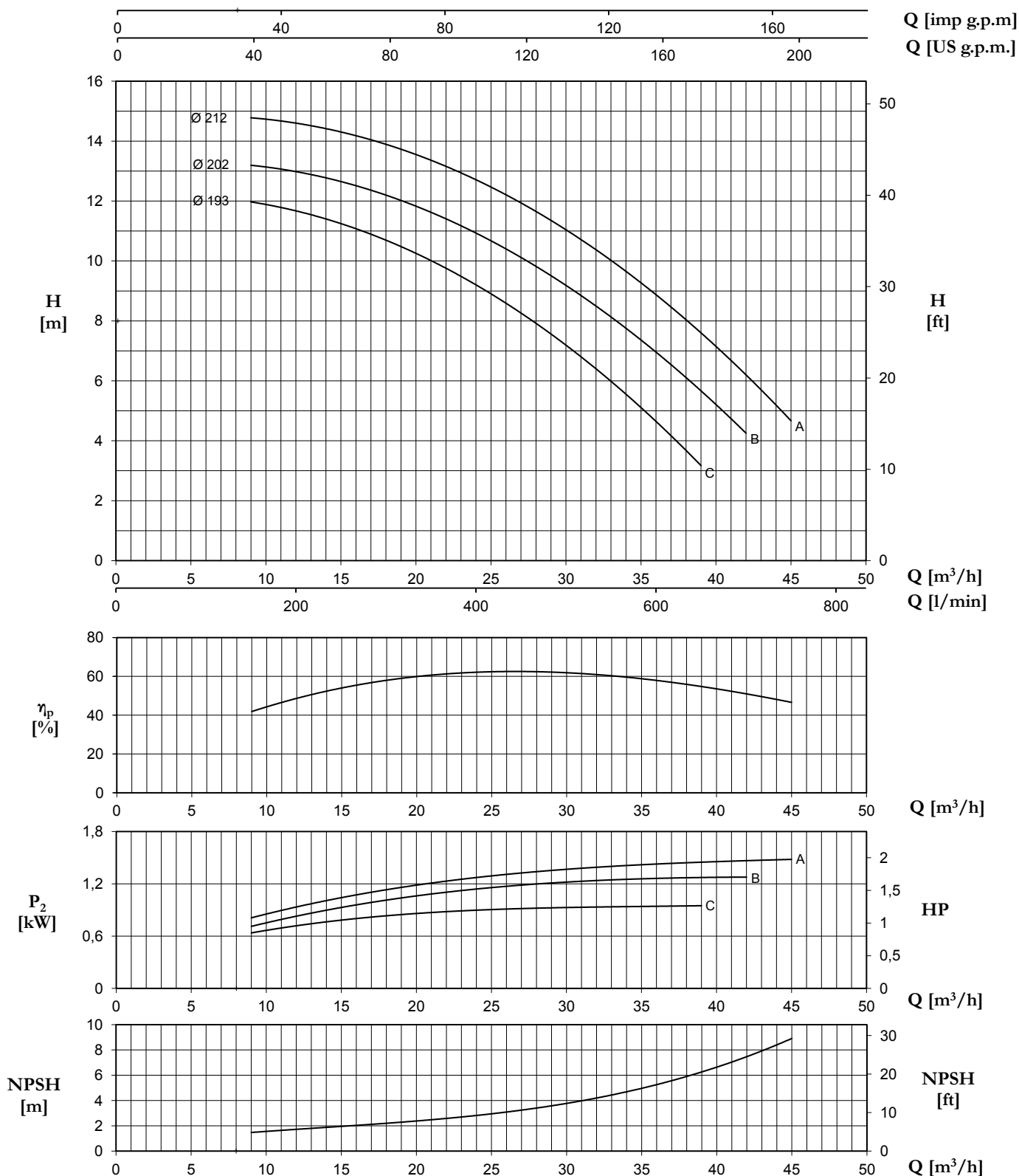

Tolerance: ISO 9906:2012 - Grade 3B

TYPE	Nominal Power (kW)	Motor Size	Q (m³/h - l/min)														
			0	9	10,5	12	15	18	21	24	27	30	33	36	39	42	45
			0	150	175	200	250	300	350	400	450	500	550	600	650	700	750
H (m) / pump input power (kW)																	
50-200C	1,1	90S	12,0	12,0	11,8	11,7	11,2	10,7	10,0	9,3	8,2	7,2	6,0	4,6	3,2		
			0,39	0,63	0,68	0,72	0,79	0,83	0,86	0,89	0,91	0,93	0,94	0,94	0,95		
50-200B	1,5	90L	13,1		13,1	13,1	12,7	12,2	11,6	10,9	10,0	9,2	8,2	7,0	5,7	4,2	
			0,48		0,77	0,83	0,92	1,02	1,09	1,14	1,18	1,22	1,24	1,24	1,27	1,27	
50-200A	1,5	90L	14,8		14,7	14,5	14,4	13,9	13,4	12,7	11,9	11,0	10,0	8,9	7,6	6,3	4,6
			0,54		0,87	0,92	1,03	1,14	1,22	1,28	1,32	1,36	1,40	1,43	1,45	1,47	1,48

4MA/4MAT - 4MAX EN 733 ~ 1450 r.p.m.

50-250

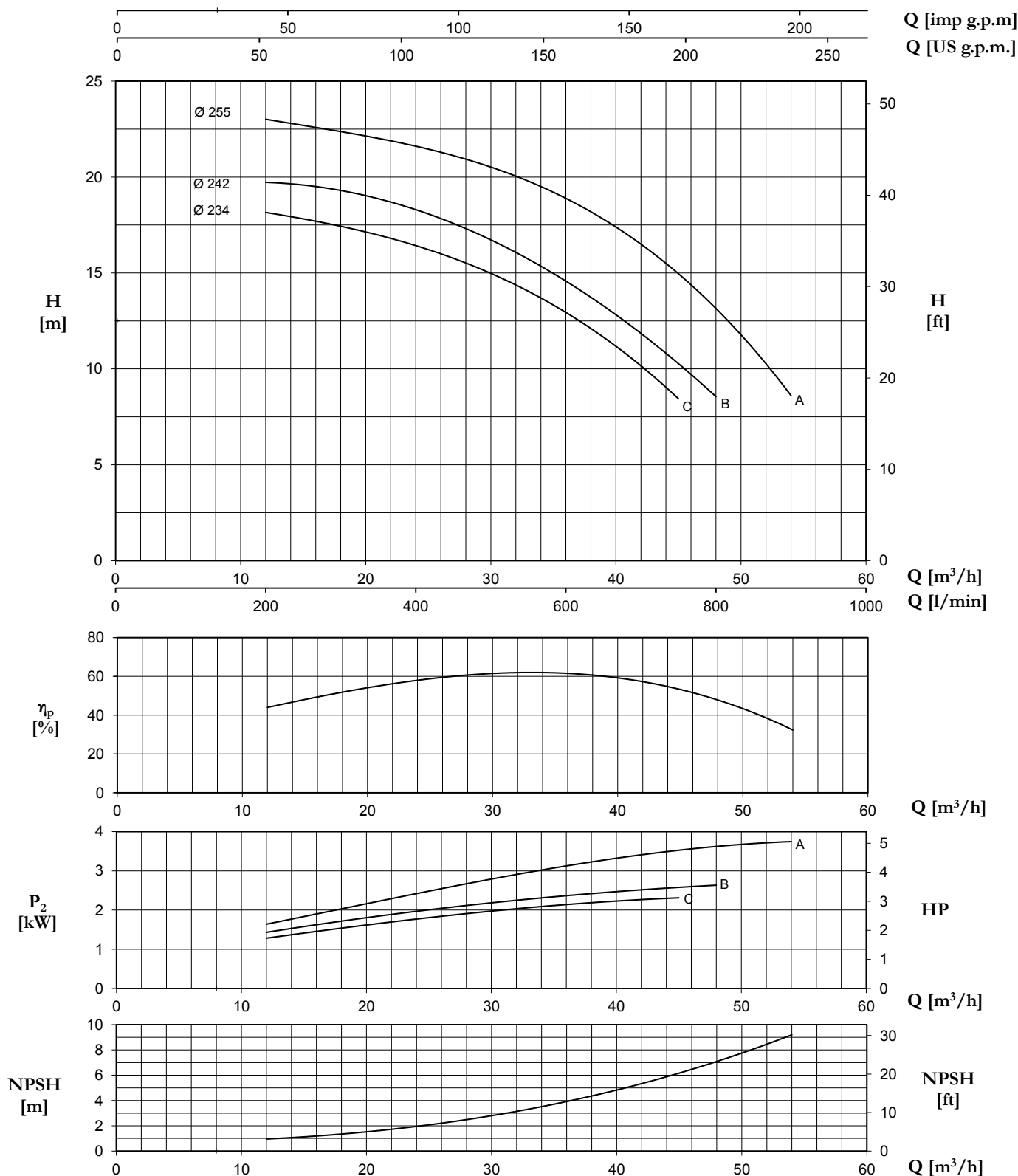

Tolerance: ISO 9906:2012 - Grade 3B

TYPE	Nominal Power (kW)	Motor Size	Q (m³/h - l/min)															
			0	12	15	18	21	24	27	30	33	36	39	42	45	48	54	
			0	200	250	300	350	400	450	500	550	600	650	700	750	800	900	
			H (m) / pump input power (kW)															
50-250C	2,2	100L	18,5	18,3	18,0	17,5	17,0	16,5	15,6	14,8	14,0	13,1	11,7	10,3	8,3			
	3	100L	0,61	1,30	1,38	1,53	1,66	1,79	1,88	1,98	2,06	2,14	2,20	2,26	2,32			
50-250B	3	100L	19,9		19,6	19,1	18,8	18,2	17,5	16,7	15,7	14,6	13,6	12,0	10,4	8,2		
			0,79		1,58	1,72	1,85	1,97	2,07	2,19	2,28	2,37	2,45	2,52	2,58	2,64		
50-250A	4	112M	23,0		22,7	22,5	22,2	21,8	21,1	20,4	19,5	18,7	17,7	16,6	15,2	13,4	8,4	
			0,90		1,84	2,07	2,21	2,42	2,60	2,78	2,95	3,12	3,28	3,43	3,53	3,62	3,74	

4MA/4MAT - 4MAX (No EN 733) ~ 1450 r.p.m.

50-315

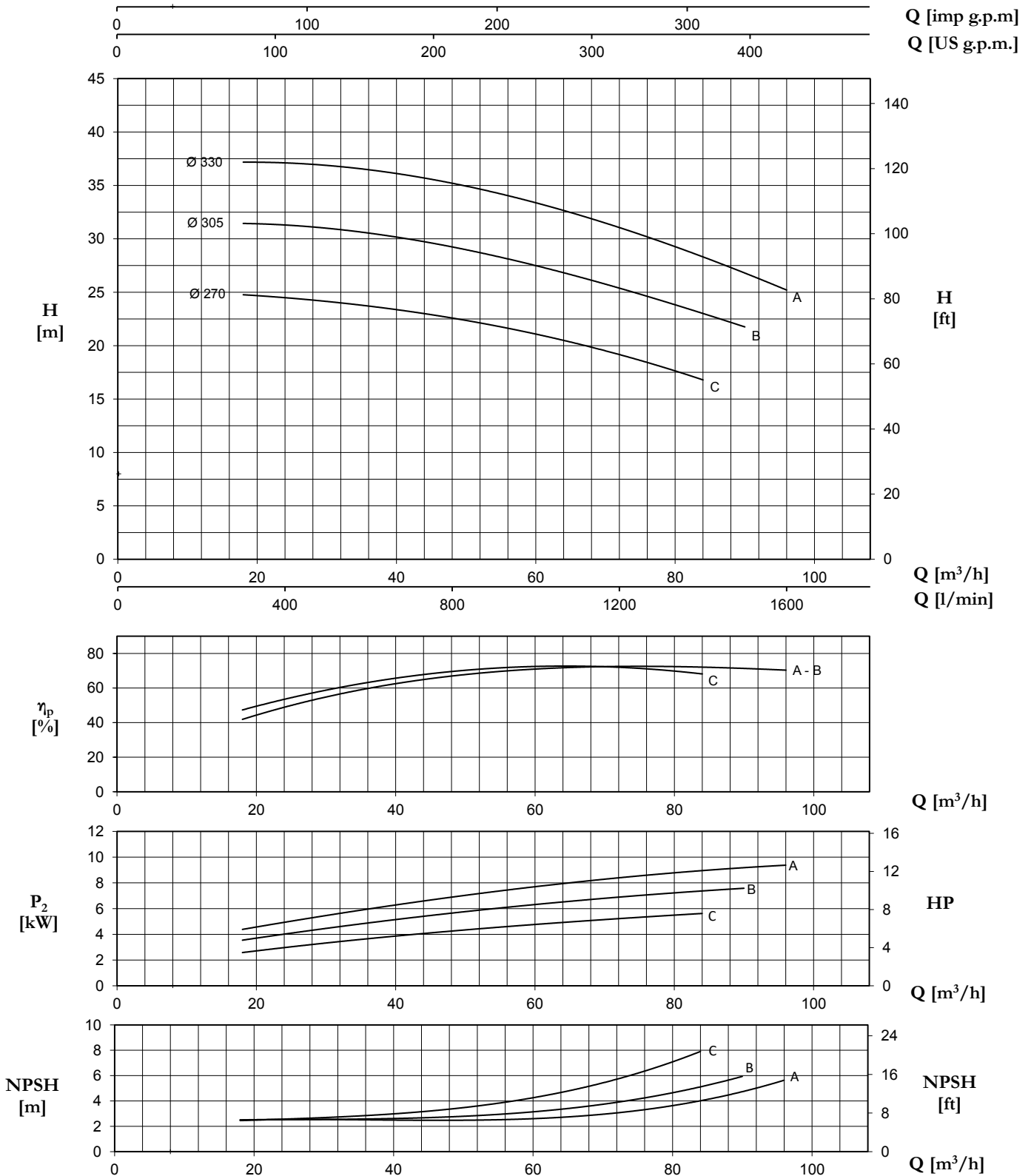

Tolerance: ISO 9906:2012 - Grade 3B

TYPE	Nominal Power (kW)	Motor Size	Q (m³/h - l/min)											
			0	18	27	36	45	60	78	84	90	96		
			0	300	450	600	750	1000	1300	1400	1500	1600		
H (m) / pump input power (kW)														
50-315C	5,5	132M	24,4	24,7	24,5	23,7	22,8	21,1	18,1	16,8				
			1,64	2,58	3,15	3,66	4,11	4,77	5,43	5,62				
50-315B	7,5	132M	31,3	31,4	31,3	30,6	29,5	27,3	24,4	23,1	21,6			
			2,35	3,54	4,24	4,89	5,46	6,32	7,14	7,37	7,58			
50-315A	11	160M	37,5	37,2	37,0	36,5	35,6	33,3	29,7	28,4	26,9	25,1		
			3,06	4,39	5,18	5,97	6,68	7,69	8,69	8,96	9,18	9,37		

4MA/4MAT - 4MAX EN 733 ~ 1450 r.p.m.

65-125

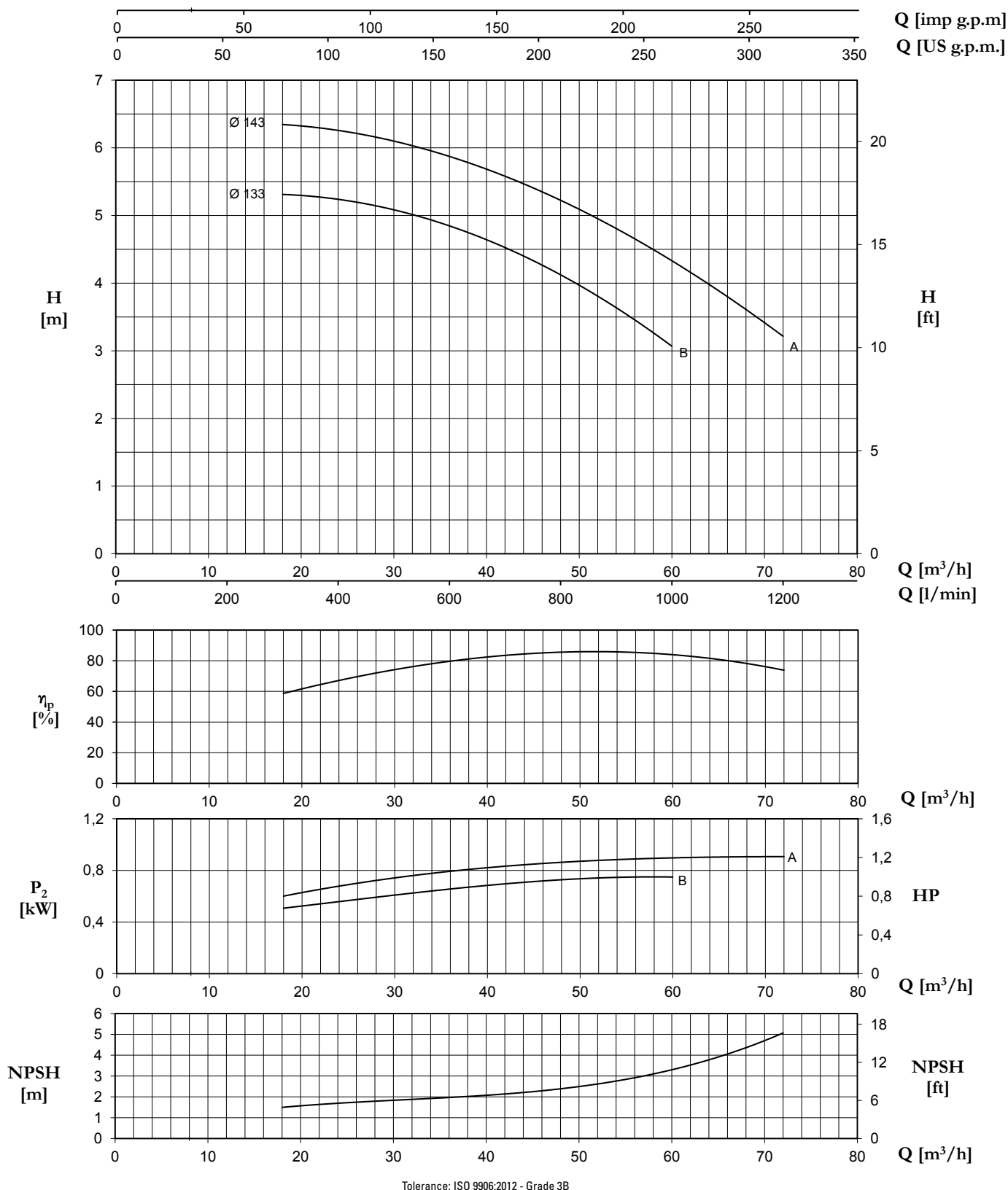

TYPE	Nominal Power (kW)	Motor Size	Q (m³/h - l/min)															
			0	18	21	24	27	30	33	36	39	42	45	48	54	60	66	72
			0	300	350	400	450	500	550	600	650	700	750	800	900	1000	1100	1200
			H (m) / pump input power (kW)															
65-125B	0,75	80M	5,1 0,33	5,3 0,51	5,3 0,53	5,2 0,56	5,2 0,59	5,1 0,60	5,0 0,63	4,8 0,66	4,7 0,68	4,6 0,70	4,3 0,71	4,1 0,73	3,6 0,74	3,1 0,75		
65-125A	1,1	90S	6,2 0,41		6,3 0,64	6,2 0,67	6,2 0,70	6,1 0,74	6,0 0,77	5,9 0,80	5,8 0,82	5,6 0,84	5,4 0,85	5,1 0,86	4,8 0,88	4,4 0,89	3,8 0,90	3,2 0,91

4MA/4MAT - 4MAX EN 733 ~ 1450 r.p.m.

65-160

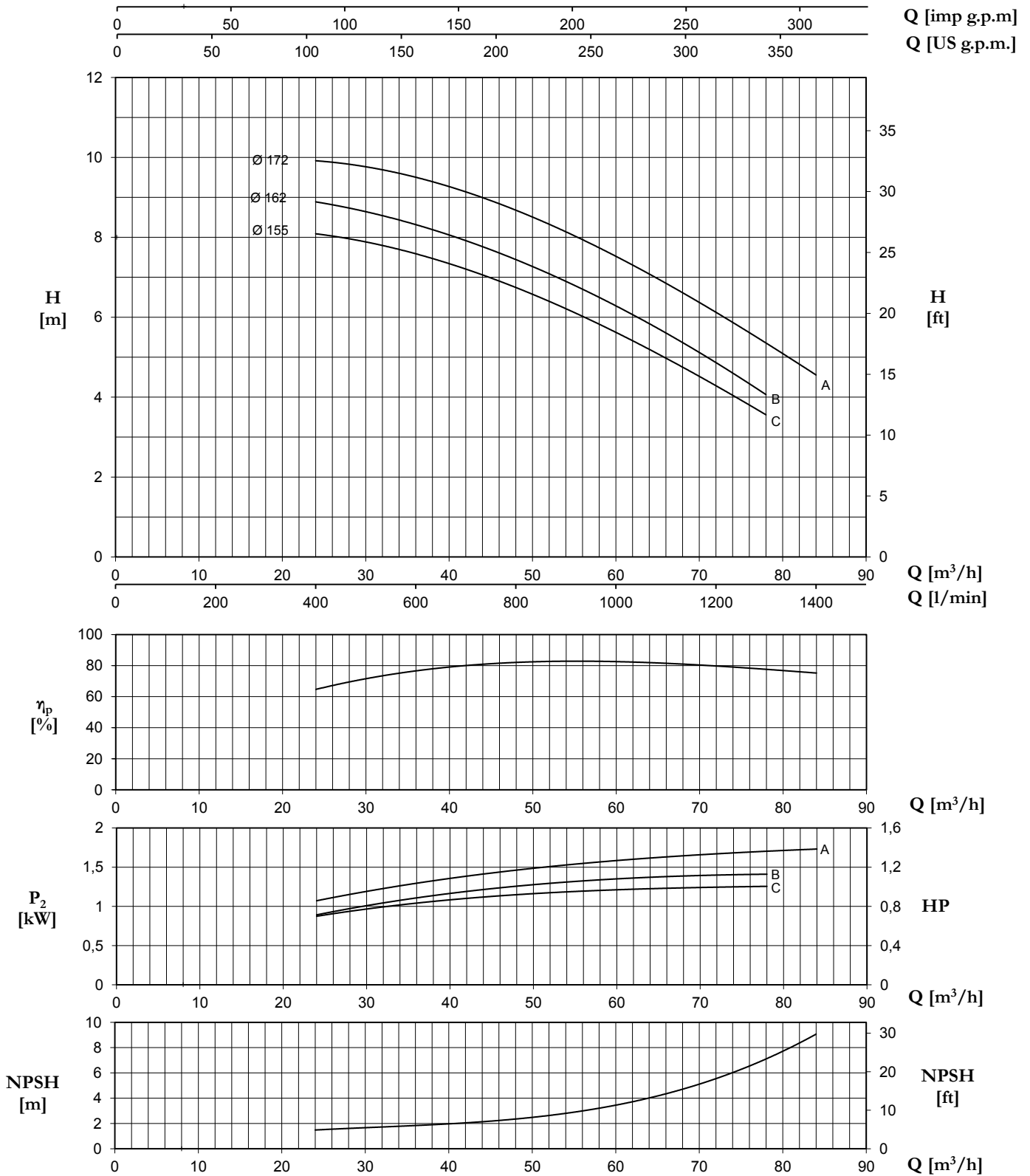

Tolerance: ISO 9906:2012 - Grade 3B

TYPE	Nominal Power (kW)	Motor Size	Q (m³/h - l/min)															
			0	24	27	30	33	36	39	42	45	48	54	60	66	72	78	84
			0	400	450	500	550	600	650	700	750	800	900	1000	1100	1200	1300	1400
H (m) / pump input power (kW)																		
65-160C	1,5	90L	7,8	8,1	8,0	7,9	7,7	7,6	7,4	7,2	7,0	6,7	6,3	5,6	5,0	4,2	3,6	
			0,48	0,87	0,92	0,97	1,01	1,05	1,08	1,11	1,12	1,14	1,16	1,22	1,24	1,25	1,25	
65-160B	1,5	90L	8,7	8,9	8,8	8,6	8,5	8,3	8,1	7,9	7,7	7,5	6,9	6,3	5,6	4,8	4,1	
			0,50	0,90	0,95	0,99	1,06	1,11	1,16	1,20	1,23	1,25	1,31	1,34	1,38	1,40	1,41	
65-160A	2,2	100L	9,8	9,9	9,9	9,8	9,6	9,5	9,3	9,1	8,9	8,7	8,2	7,6	6,8	6,1	5,3	4,6
			0,66	1,06	1,14	1,20	1,25	1,30	1,34	1,39	1,42	1,46	1,52	1,58	1,63	1,67	1,72	1,72

4MA/4MAT - 4MAX EN 733 ~ 1450 r.p.m.

65-200

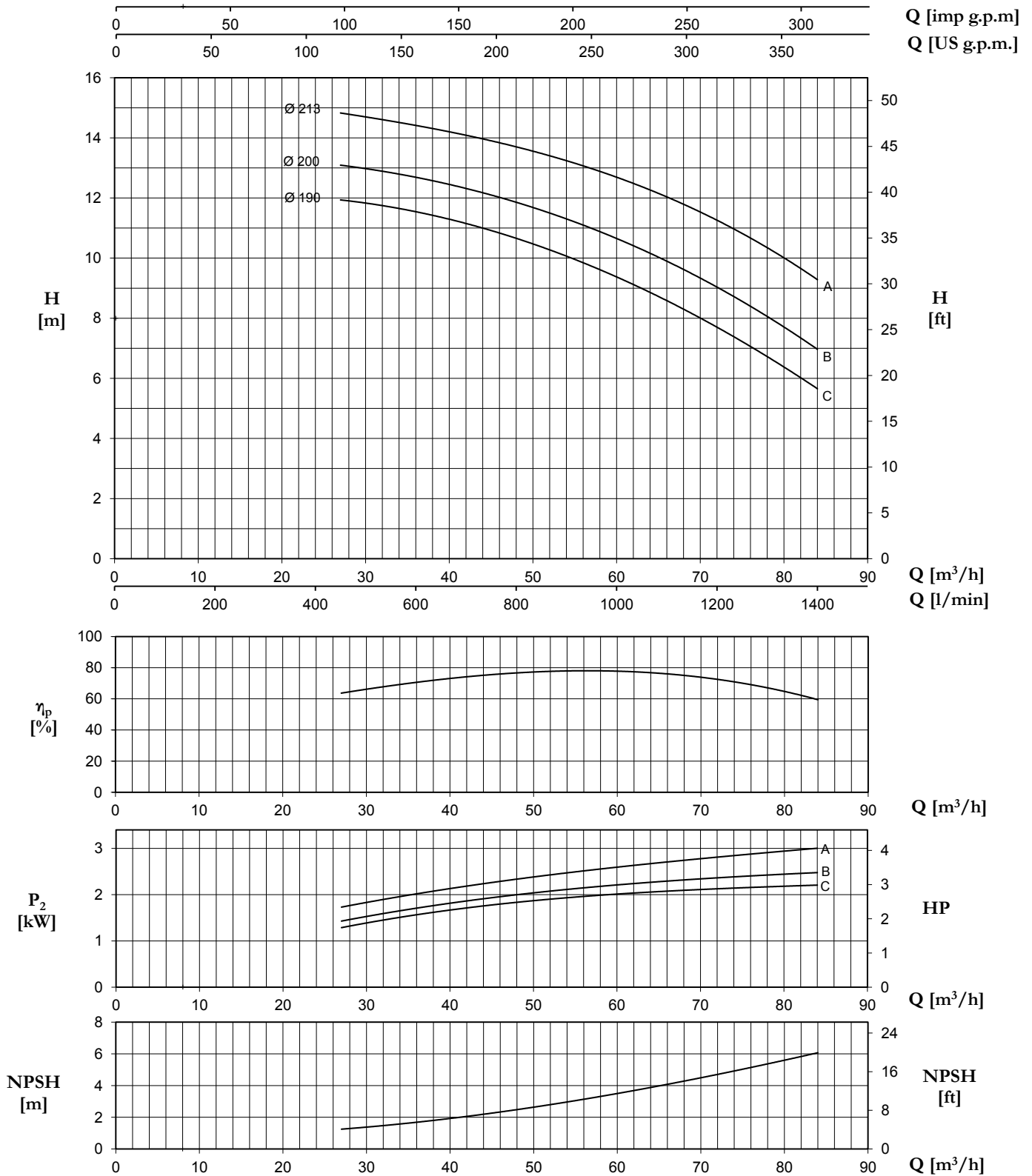

Tolerance: ISO 9906:2012 - Grade 3B

TYPE	Nominal Power (kW)	Motor Size	Q (m³/h - l/min)														
			0	27	30	33	36	39	42	45	48	54	60	66	72	78	84
			0	450	500	550	600	650	700	750	800	900	1000	1100	1200	1300	1400
H (m) / pump input power (kW)																	
65-200C	2,2	100L	11,2 0,50	11,9 1,29	11,8 1,38	11,7 1,48	11,6 1,57	11,5 1,65	11,2 1,71	10,8 1,77	10,6 1,83	10,0 1,95	9,4 2,01	8,6 2,07	7,7 2,12	6,8 2,17	5,6 2,21
65-200B	3	100L	12,3 0,69	13,1 1,45	13,0 1,51	12,8 1,61	12,7 1,70	12,5 1,77	12,3 1,88	12,1 1,95	11,9 2,01	11,3 2,11	10,6 2,21	10,0 2,29	9,0 2,36	8,0 2,42	7,0 2,48
65-200A	3	100L	14,0 1,12	14,8 1,74	14,7 1,82	14,6 1,92	14,5 2,02	14,2 2,10	14,0 2,18	13,9 2,26	13,7 2,34	13,3 2,48	12,7 2,59	12,0 2,70	11,3 2,81	10,3 2,91	9,3 3,00

4MA/4MAT - 4MAX EN 733 ~ 1450 r.p.m.

65-250

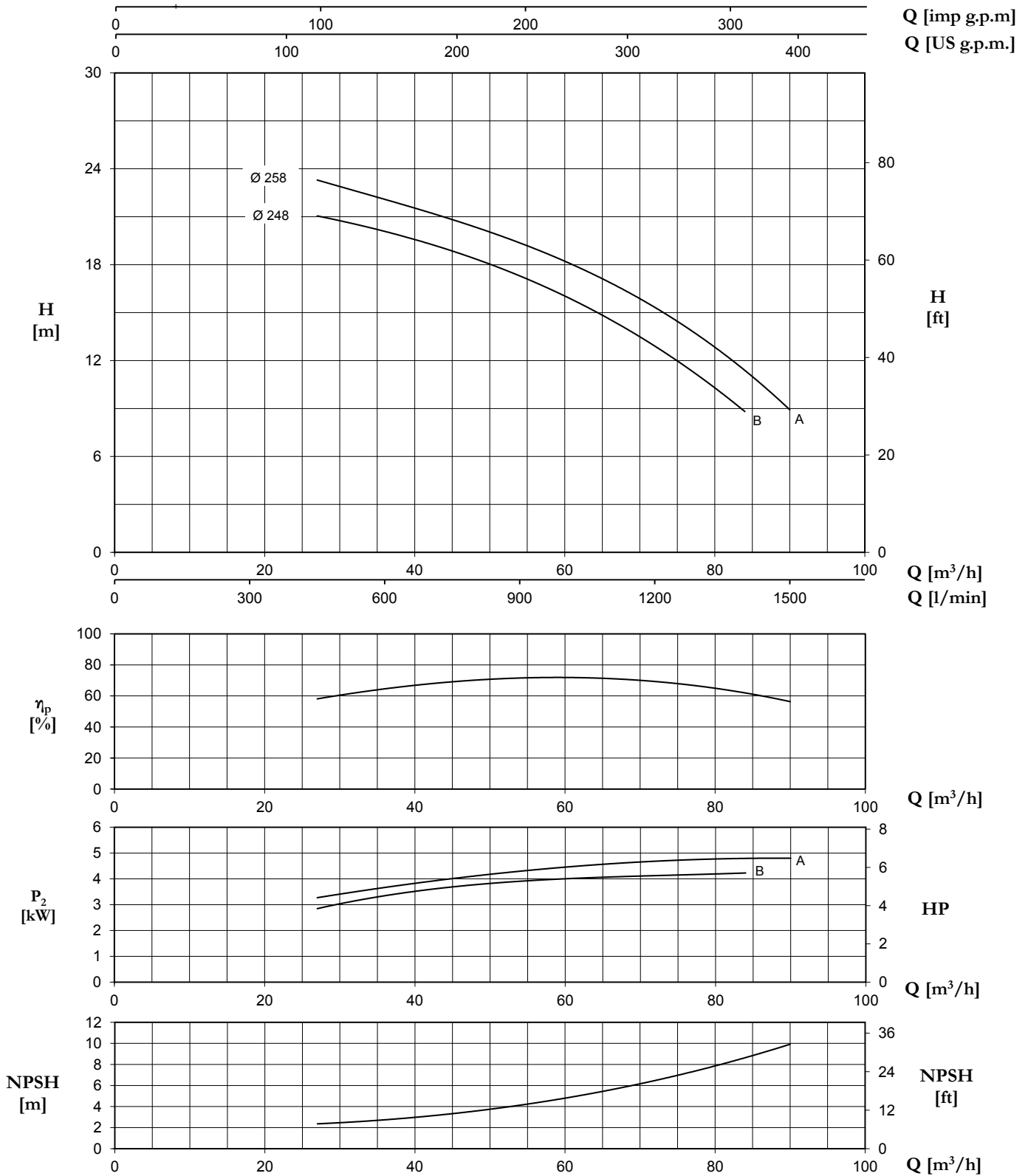

Tolerance: ISO 9906:2012 - Grade 3B

TYPE	Nominal Power (kW)	Motor Size	Q (m³/h - l/min)															
			0	27	30	33	36	39	42	45	48	54	60	66	72	78	84	90
			0	450	500	550	600	650	700	750	800	900	1000	1100	1200	1300	1400	1500
			H (m) / pump input power (kW)															
65-250B	4	112M	20,6	21,0	20,8	20,4	20,1	19,8	19,3	18,8	18,4	17,3	16,0	14,5	12,9	11,2	8,7	
	5,5	132S	1,42	2,87	2,98	3,18	3,38	3,50	3,61	3,70	3,78	3,87	3,97	4,07	4,17	4,19	4,21	
65-250A	5,5	132S	22,8	22,9	22,5	22,1	21,7	21,4	20,9	20,4	19,2	18,0	16,9	15,4	13,6	11,5	8,8	
			1,58	3,41	3,56	3,70	3,79	3,88	4,00	4,11	4,31	4,44	4,58	4,71	4,75	4,79	4,80	

4MA/4MAT - 4MAX EN 733 ~ 1450 r.p.m.

65-315

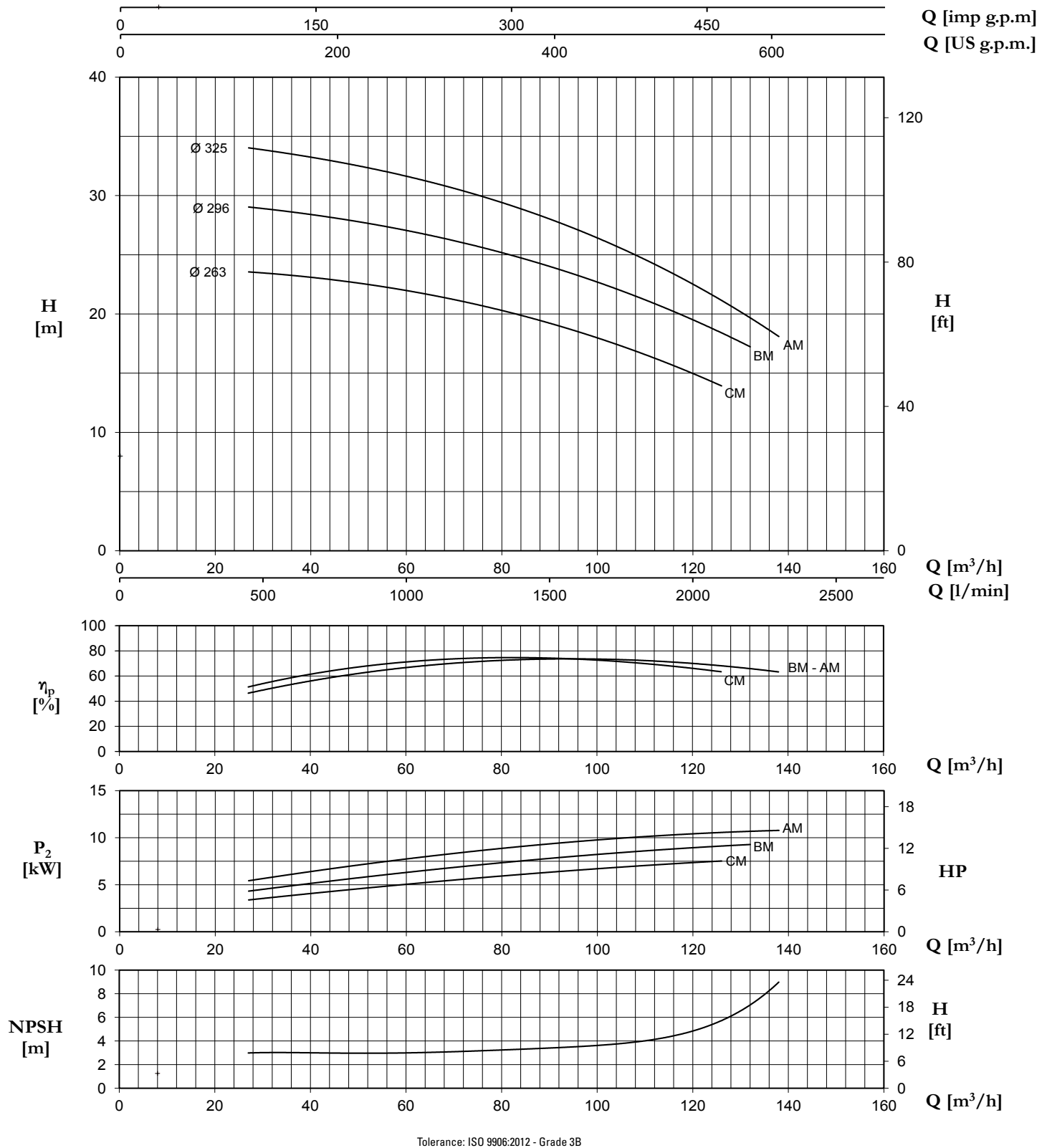

Tolerance: ISO 9906:2012 - Grade 3B

TYPE	Nominal Power (kW)	Motor Size	Q (m³/h - l/min)									
			0	27	36	45	60	78	102	126	132	138
			0	450	600	750	1000	1300	1700	2100	2200	2300
H (m) / pump input power (kW)												
65-315 CM	7,5	132M	23,0	23,5	23,3	22,9	21,9	20,5	17,7	13,9		
			2,05	3,38	3,86	4,32	5,05	5,84	6,77	7,52		
65-315 BM	11	160M	28,9	28,9	28,7	28,2	27,0	25,3	22,5	18,4	17,2	
			2,72	4,33	4,89	5,42	6,33	7,24	8,30	9,10	9,29	
65-315 AM	11	160M	34,5	34,0	33,5	32,9	31,6	29,6	26,2	21,1	19,6	18,2
			3,44	5,43	6,10	6,75	7,73	8,78	9,84	10,55	10,68	10,78

4MA/4MAT - 4MAX EN 733 ~ 1450 r.p.m.

80-160

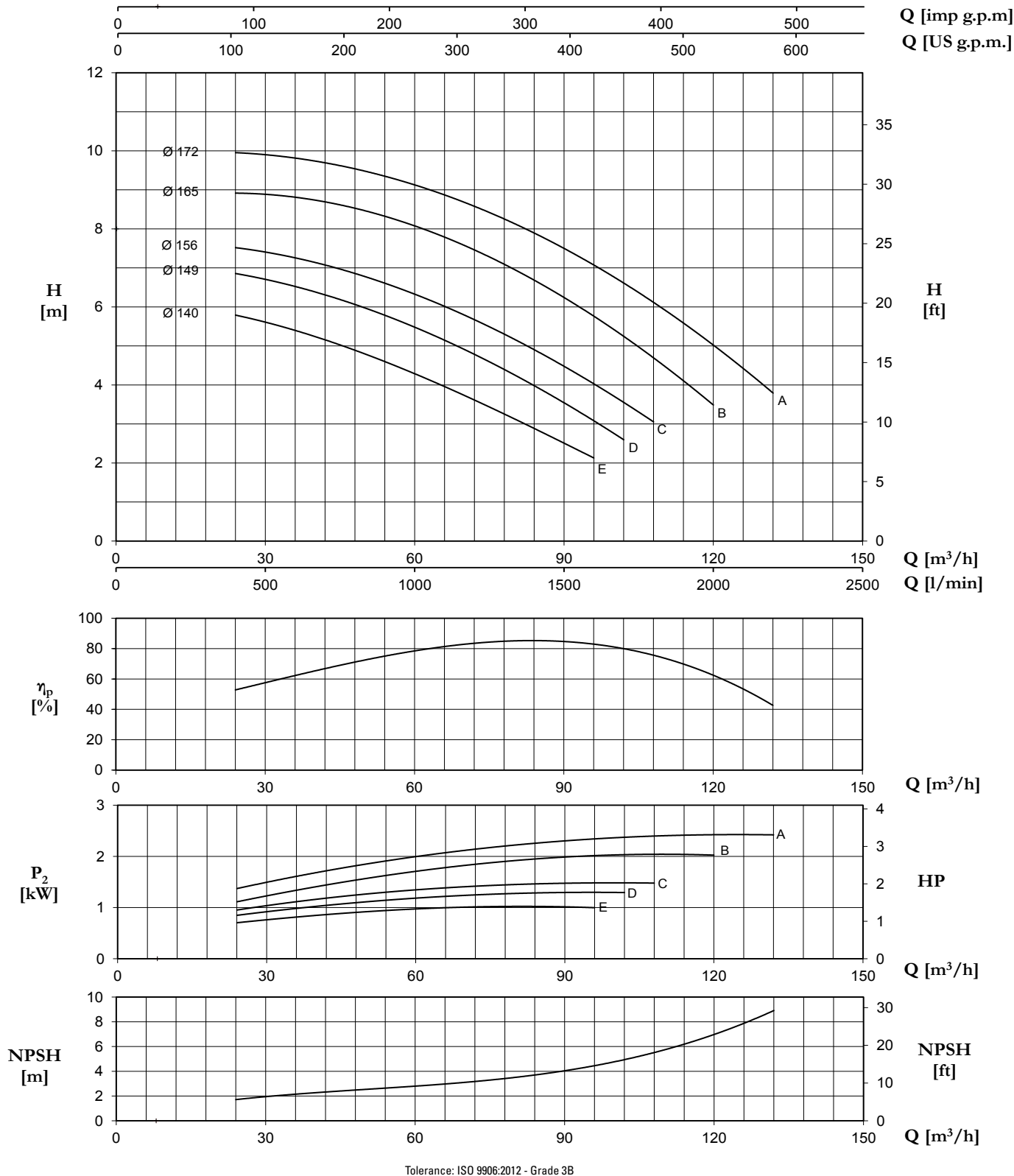

TYPE	Nominal Power (kW)	Motor Size	Q (m³/h - l/min)															
			0	24	27	30	33	36	42	48	60	72	84	96	102	108	120	132
			0	400	450	500	550	600	700	800	1000	1200	1400	1600	1700	1800	2000	2200
			H (m) / pump input power (kW)															
80-160E	1,1	90S	5,5 0,35	5,7 0,71	5,7 0,74	5,7 0,74	5,6 0,78	5,4 0,81	5,1 0,88	4,9 0,90	4,2 0,97	3,8 1,02	2,8 1,02	2,2 1,00				
80-160D	1,5	90L	6,3 0,61		6,8 0,89	6,7 0,91	6,6 0,95	6,5 0,98	6,3 1,04	6,1 1,10	5,5 1,19	4,8 1,25	4 1,28	3,1 1,30	2,6 1,29			
80-160C	1,5	90L	7 0,67			7,4 1,04	7,3 1,08	7,3 1,12	7,1 1,18	6,8 1,25	6,4 1,35	5,7 1,42	4,9 1,47	4 1,48	3,5 1,48	3,1 1,48		
80-160B	2,2	100L	8,5 0,62				8,9 1,29	8,9 1,35	8,7 1,43	8,5 1,51	8,0 1,72	7,5 1,87	6,8 1,95	5,7 2,01	5,2 2,02	4,7 2,04	3,5 2,04	
80-160A	3	100L	9,3 1,09					9,8 1,60	9,7 1,71	9,5 1,81	9,1 2,01	8,6 2,14	7,9 2,27	7,1 2,34	6,6 2,37	6,2 2,39	5,0 2,42	3,8 2,43

4MA/4MAT - 4MAX EN 733 ~ 1450 r.p.m.

80-200

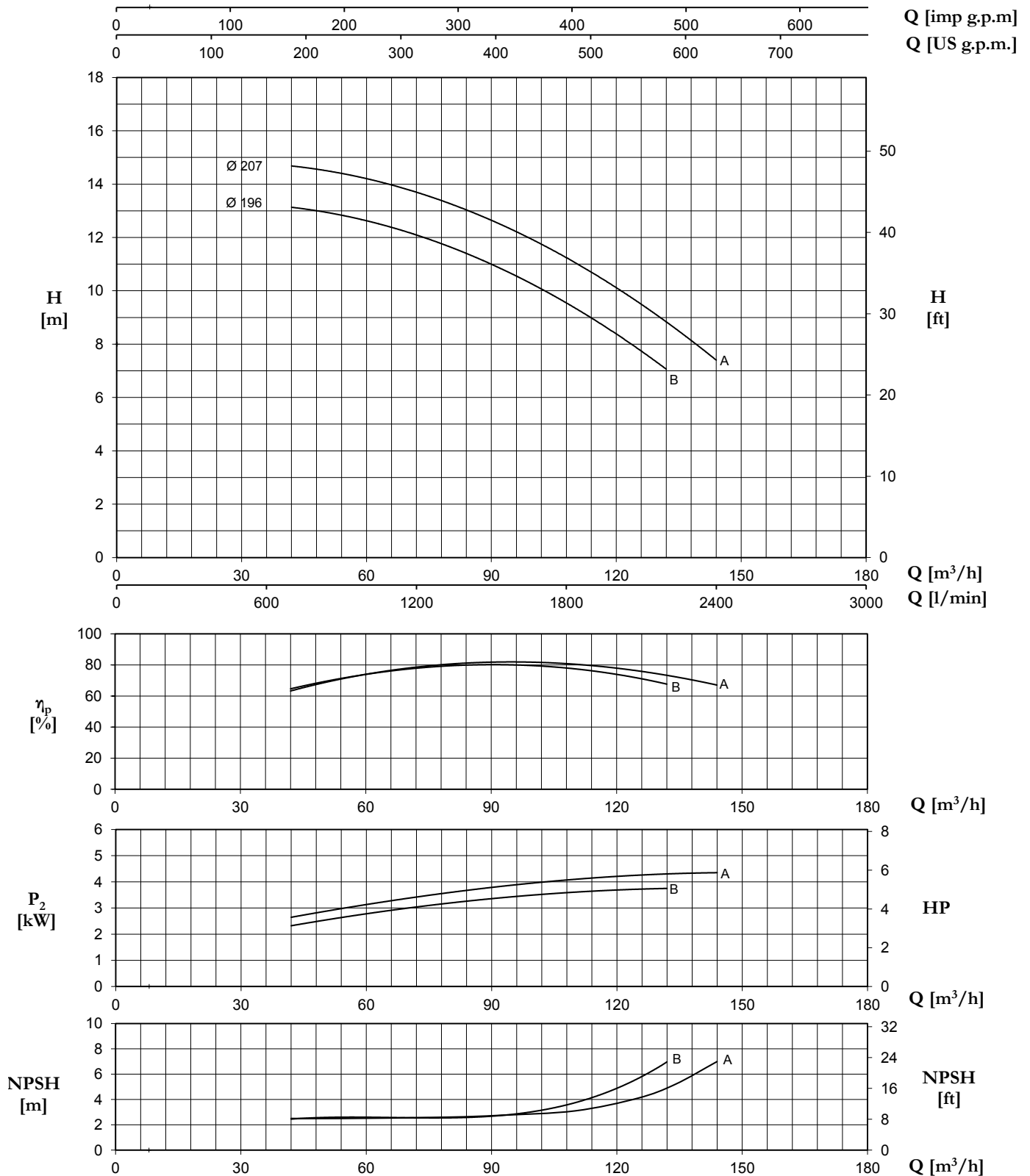

Tolerance: ISO 9906:2012 - Grade 3B

TYPE	Nominal Power (kW)	Motor Size	Q (m³/h - l/min)									
			0	42	60	84	96	102	108	120	132	144
			0	700	1000	1400	1600	1700	1800	2000	2200	2400
H (m) / pump input power (kW)												
80-200B	4	112M	12,3	13,1	12,6	11,4	10,5	10,1	9,6	8,4	7,1	
			1,25	2,32	2,79	3,26	3,45	3,52	3,58	3,69	3,75	
80-200A	5,5	132S	13,8	14,7	14,2	13,1	12,3	11,7	11,2	10,1	8,8	7,5
			1,40	2,64	3,14	3,66	3,87	3,99	4,09	4,21	4,30	4,35

4MA/4MAT - 4MAX EN 733 ~ 1450 r.p.m.

80-250

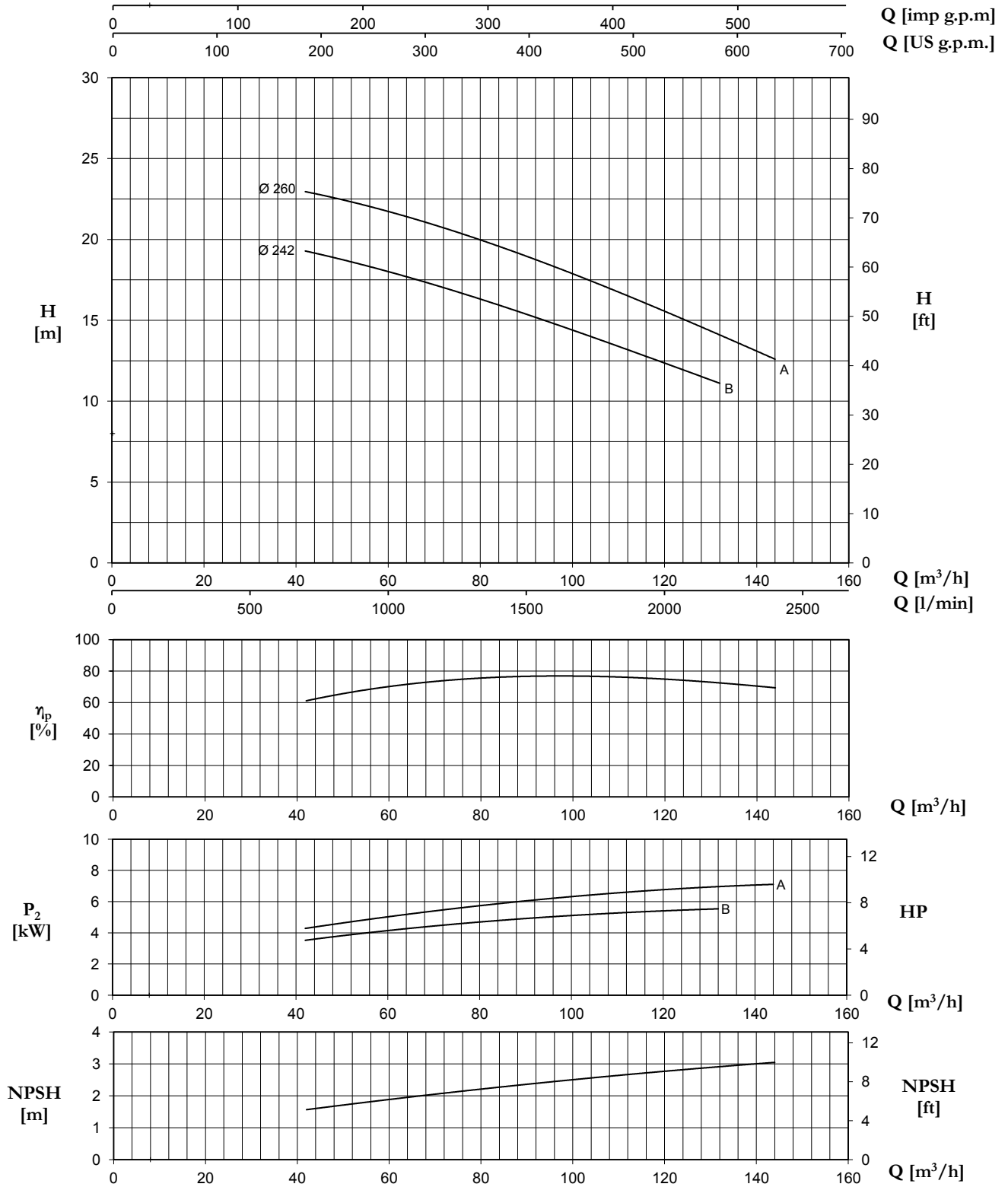

Tolerance: ISO 9906:2012 - Grade 3B

TYPE	Nominal Power (kW)	Motor Size	Q (m³/h - l/min)											
			0	42	48	60	72	84	96	102	108	120	132	144
			0	700	800	1000	1200	1400	1600	1700	1800	2000	2200	2400
H (m) / pump input power (kW)														
80-250B	5,5	132S	18,9	19,2	19,0	18,1	17,0	15,9	14,8	14,2	13,6	12,4	11,1	
			1,79	3,52	3,75	4,14	4,48	4,78	5,05	5,16	5,24	5,41	5,54	
80-250A	7,5	132S	22,4	22,9	22,6	21,8	20,7	19,6	18,3	17,7	17,0	15,6	14,2	12,6
			2,22	4,28	4,56	5,05	5,46	5,85	6,21	6,37	6,52	6,77	6,96	7,10

4MA/4MAT - 4MAX EN 733 ~ 1450 r.p.m.

80-315

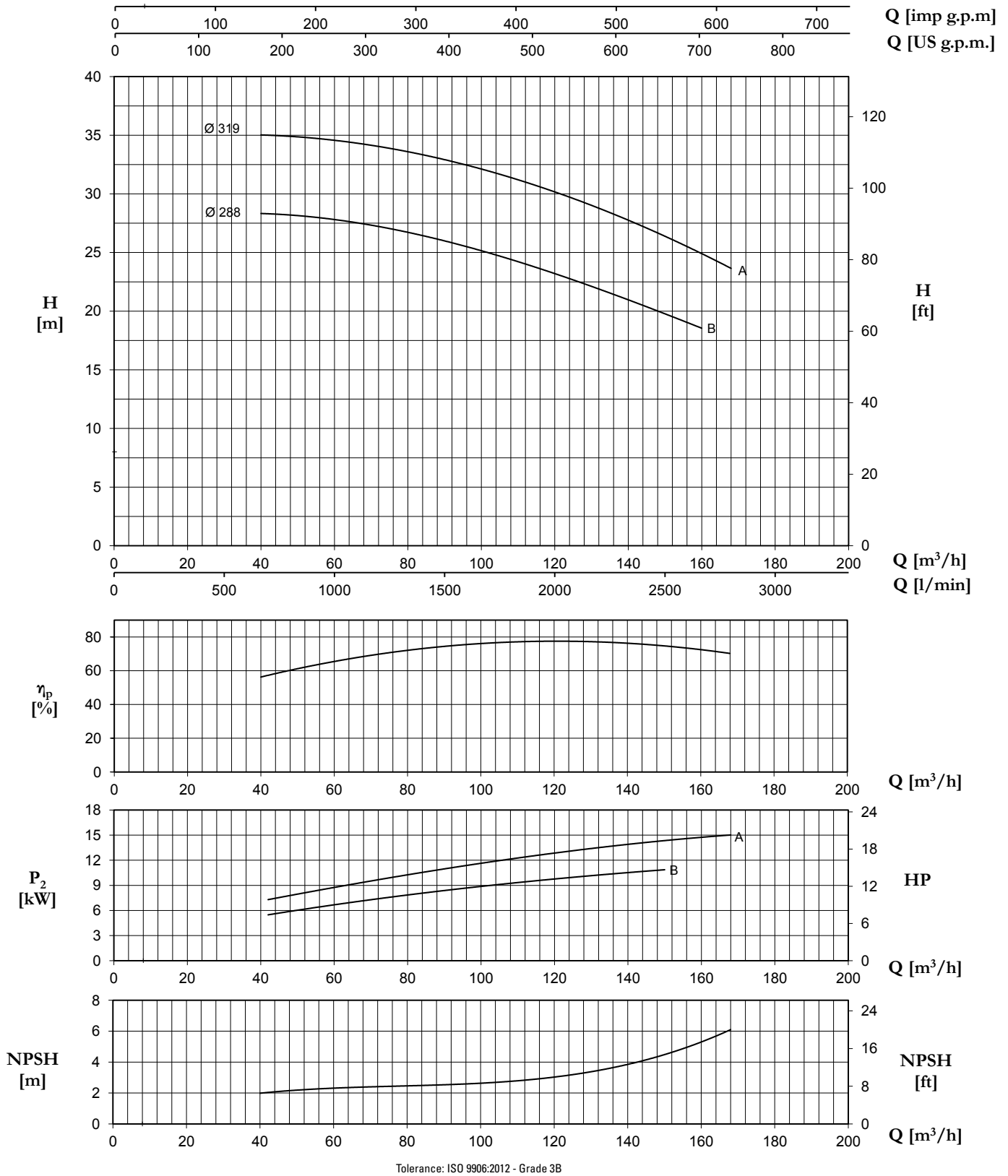

TYPE	Nominal Power (kW)	Motor Size	Q (m³/h - l/min)													
			0	48	60	72	84	96	102	108	120	132	144	150	156	168
			0	800	1000	1200	1400	1600	1700	1800	2000	2200	2400	2500	2600	2800
			H (m) / pump input power (kW)													
80-315B	11	160M	27,7	28,2	27,9	27,2	26,4	25,4	24,9	24,4	23,2	21,9	20,5	19,9		
			2,99	5,88	6,67	7,42	8,09	8,67	8,95	9,21	9,74	10,28	10,69	10,87		
80-315A	15	160L	34,5	34,9	34,6	34,1	33,3	32,4	31,9	31,3	30,1	28,8	27,3	26,4	25,6	23,7
			4,29	7,79	8,75	9,66	10,53	11,36	11,77	12,17	12,91	13,50	14,04	14,31	14,56	15,04

4MA/4MAT - 4MAX EN 733 ~ 1450 r.p.m.

100-200

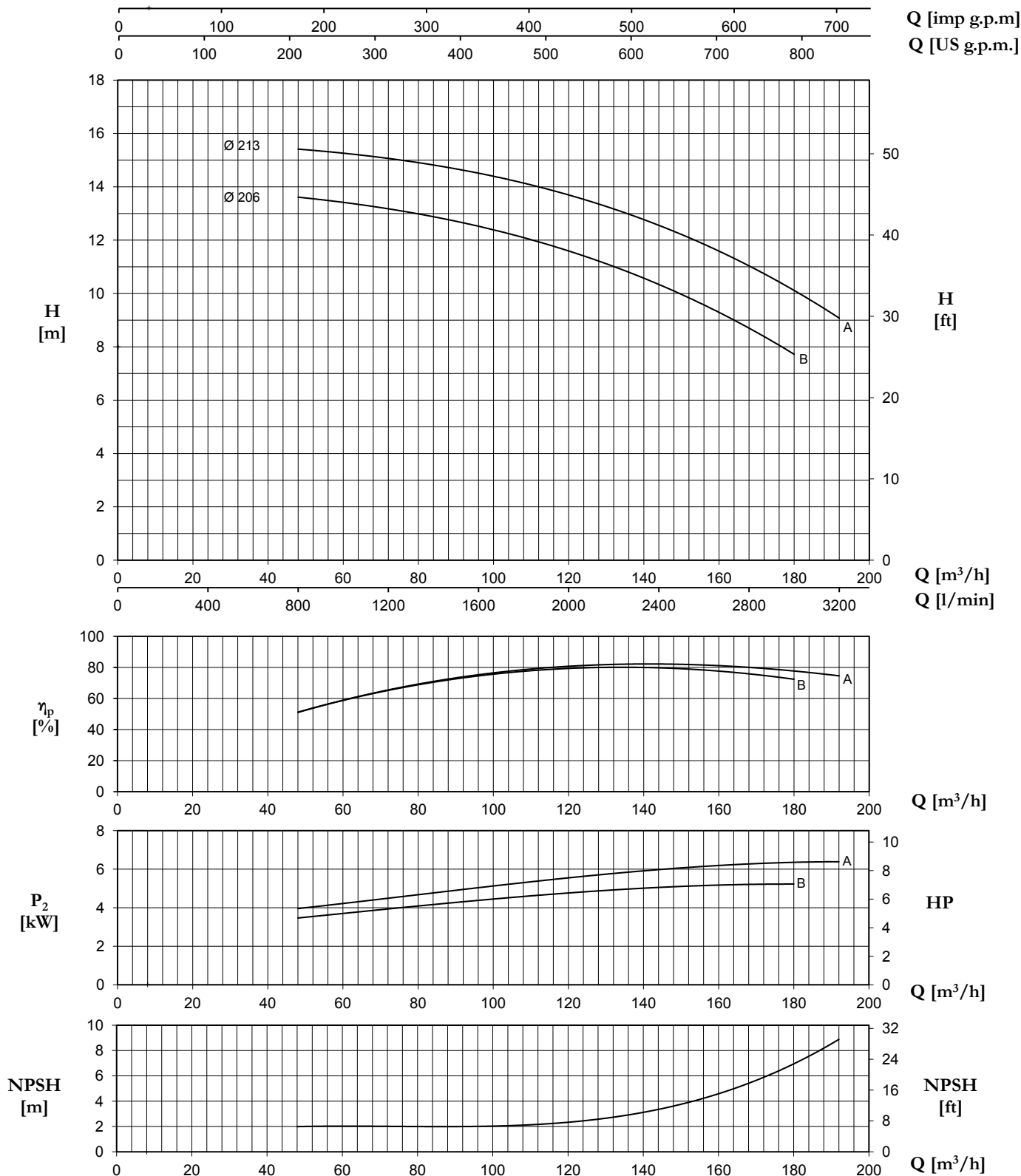

Tolerance: ISO 9906:2012 - Grade 3B

TYPE	Nominal Power (kW)	Motor Size	Q (m³/h - l/min)															
			0	48	60	72	84	96	102	108	120	132	144	150	156	168	180	192
			0	800	1000	1200	1400	1600	1700	1800	2000	2200	2400	2500	2600	2800	3000	3200
			H (m) / pump input power (kW)															
100-200B	5,5	132S	13,5	13,6	13,4	13,1	12,8	12,5	12,3	12,1	11,6	11,0	10,3	9,9	9,5	8,7	7,8	
			2,79	3,48	3,70	3,93	4,15	4,38	4,49	4,59	4,77	4,93	5,05	5,09	5,13	5,19	5,23	
100-200A	7,5	132M	15,2	15,4	15,3	15,0	14,8	14,5	14,4	14,2	13,8	13,2	12,5	12,2	11,8	11,0	10,1	
			3,12	3,96	4,22	4,48	4,74	5,03	5,17	5,31	5,58	5,80	5,99	6,07	6,13	6,23	6,33	6,40

4MA/4MAT - 4MAX EN 733 ~ 1450 r.p.m.

100-250

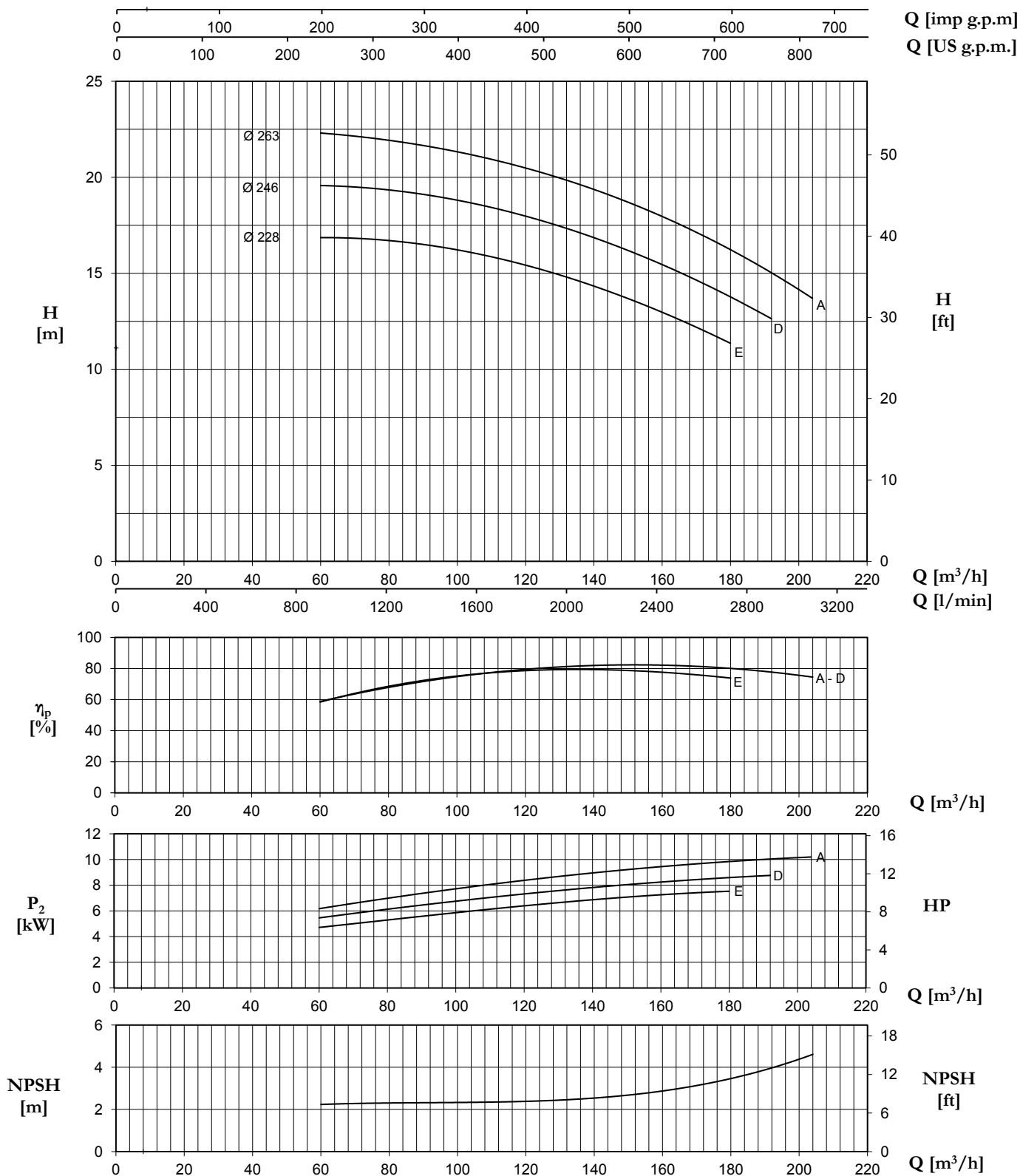

Tolerance: ISO 9906:2012 - Grade 3B

TYPE	Nominal Power (kW)	Motor Size	Q (m³/h - l/min)															
			0	60	72	84	96	102	108	120	132	144	150	156	168	192	204	
			0	1000	1200	1400	1600	1700	1800	2000	2200	2400	2500	2600	2800	3200	3400	
			H (m) / pump input power (kW)															
100-250E	7,5	132M	16,7	16,9	16,8	16,6	16,3	16,2	16,0	15,5	14,8	13,6	13,2	12,4				
			3,06	4,71	5,06	5,42	5,75	5,91	6,07	6,39	6,69	6,96	7,08	7,19	7,38			
100-250D	7,5	160M	19,6	19,6	19,4	19,2	18,9	18,7	18,5	18,0	17,4	16,6	16,2	15,7	14,8	12,7		
			3,39	5,44	5,88	6,29	6,66	6,82	6,98	7,30	7,60	7,90	8,05	8,19	8,41	8,75		
100-250A	11	160M	22,6	22,3	22,1	21,8	21,4	21,2	21,0	20,5	19,9	19,1	18,7	18,3	17,3	15,0	13,8	
			3,96	6,17	6,67	7,15	7,59	7,80	8,00	8,37	8,71	9,04	9,20	9,36	9,63	10,04	10,19	

4MA/4MAT - 4MAX EN 733 ~ 1450 r.p.m.

100-315

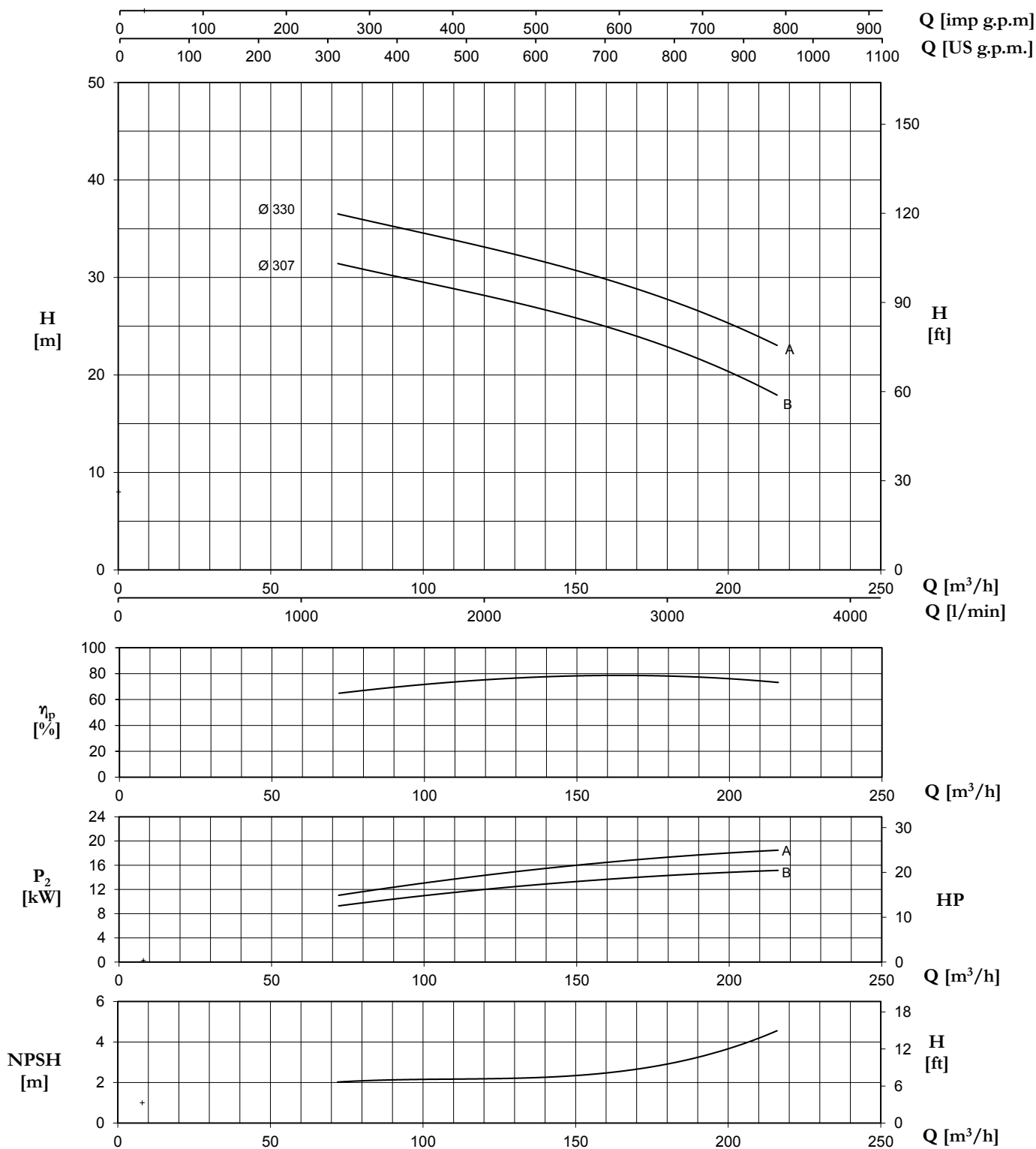

Tolerance: ISO 9906:2012 - Grade 3B

TYPE	Nominal Power (kW)	Motor Size	Q (m³/h - l/min)									
			0	72	78	84	108	132	156	180	204	216
			0	1200	1300	1400	1800	2200	2600	3000	3400	3600
H (m) / pump input power (kW)												
100-315B	15	160L	31,8	31,4	31,0	30,6	29,0	27,3	25,3	23,0	19,7	17,9
			4,74	9,27	9,67	10,05	11,42	12,54	13,54	14,31	14,92	15,14
100-315A	18,5	180M	37,1	36,5	36,1	35,7	34,0	32,2	30,2	27,9	24,7	23,1
			5,63	11,03	11,49	11,94	13,60	15,01	16,32	17,32	18,15	18,49

4MA/4MAT - 4MAX EN 733 ~ 1450 r.p.m.

100-400

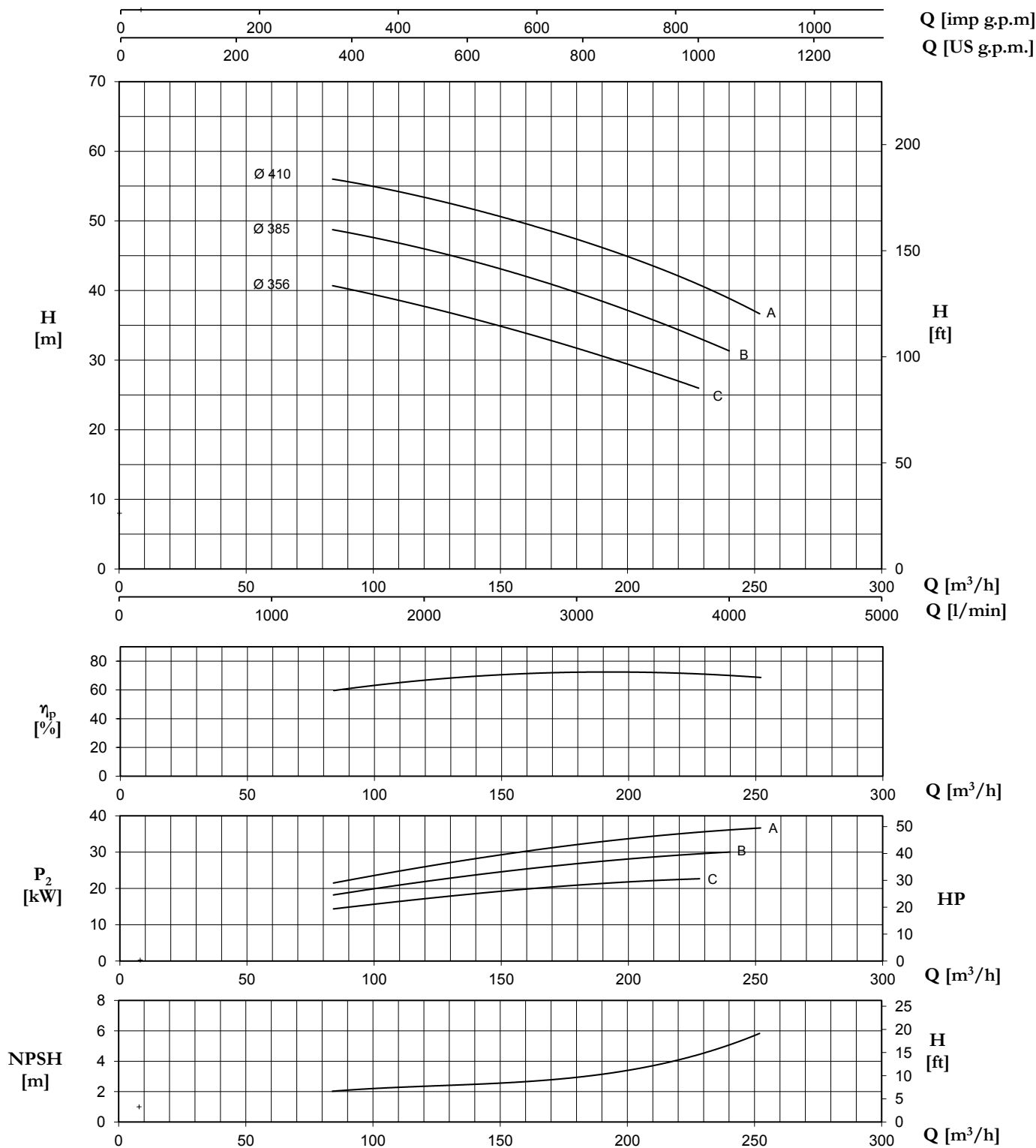

Tolerance: ISO 9906:2012 - Grade 3B

TYPE	Nominal Power (kW)	Motor Size	Q (m³/h - l/min)												
			0	84	108	132	156	180	204	216	228	240	252		
			0	1400	1800	2200	2600	3000	3400	3600	3800	4000	4200		
H (m) / pump input power (kW)															
100-400C	22	180L	42,4 6,93	40,6 14,36	38,8 16,27	36,7 17,98	34,3 19,64	31,4 20,95	29,1 21,91	27,7 22,31	25,8 22,70				
100-400B	30	200L	50,3 9,32	48,7 18,20	47,0 20,75	44,9 23,04	42,6 25,03	39,8 26,80	36,5 28,36	34,7 29,01	33,1 29,56	31,6 30,00			
100-400A	37	225S	58,3 11,46	56,0 21,50	54,3 24,54	52,4 27,31	50,1 29,89	47,3 32,15	44,3 34,00	42,7 34,77	40,9 35,48	38,8 36,11	36,7 36,69		

4MA/4MAT - 4MAX EN 733 ~ 1450 r.p.m.

125-250

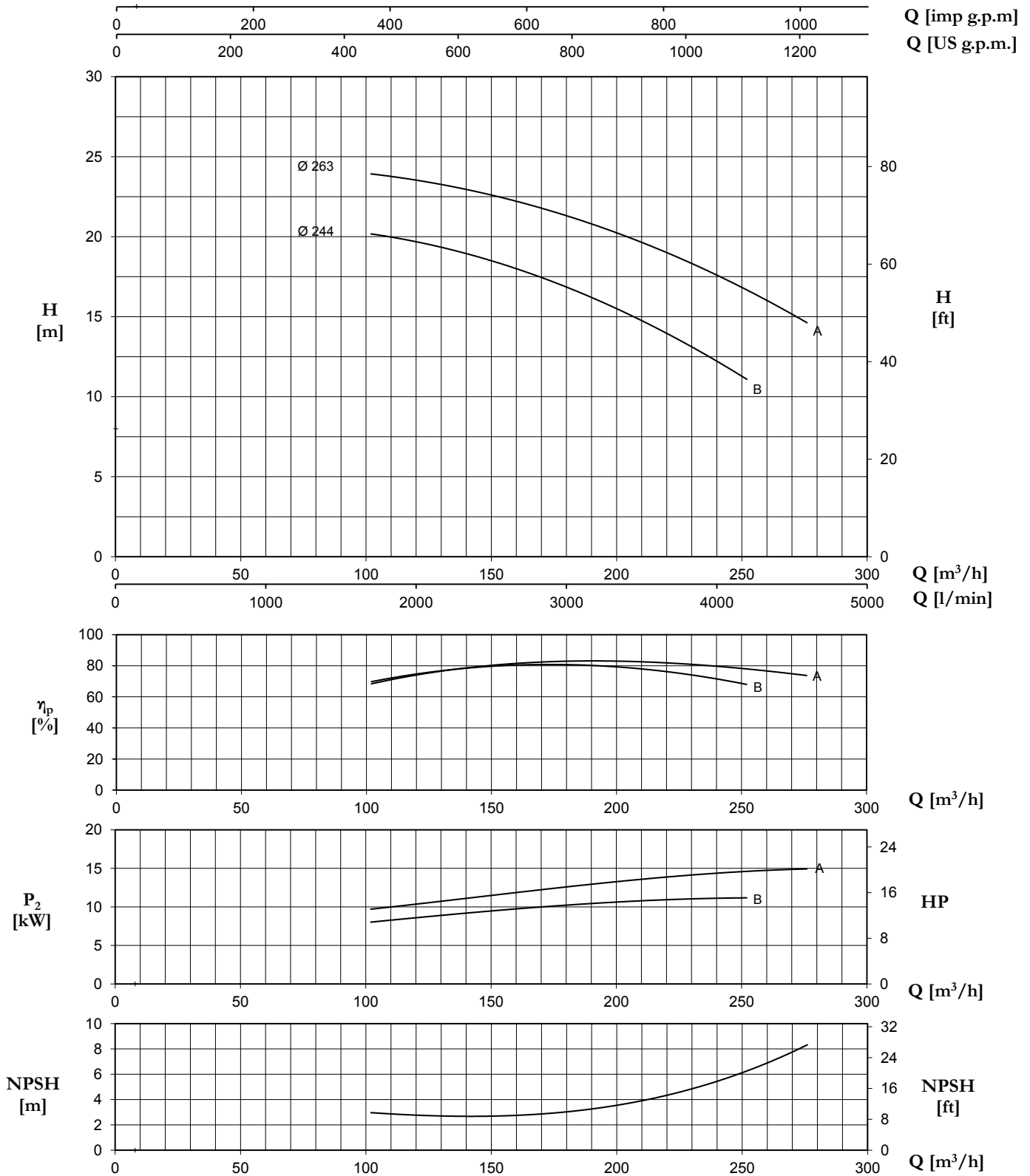

Tolerance: ISO 9906:2012 - Grade 3B

TYPE	Nominal Power (kW)	Motor Size	Q (m³/h - l/min)										
			0	102	114	126	138	150	168	192	216	252	276
			0	1700	1900	2100	2300	2500	2800	3200	3600	4200	4600
			H (m) pump input power (kW)										
125-250B	11	160M	19,6 5,41	20,2 8,04	19,8 8,40	19,5 8,75	19,0 9,11	18,5 9,50	17,6 9,99	16,1 10,44	14,3 10,88	11,1 11,18	
125-250A	15	160L	23,2 6,18	24,0 9,71	23,6 10,14	23,3 10,57	23,0 11,02	22,6 11,47	21,9 12,16	20,7 13,02	19,3 13,77	16,6 14,57	14,7 14,94

125-315

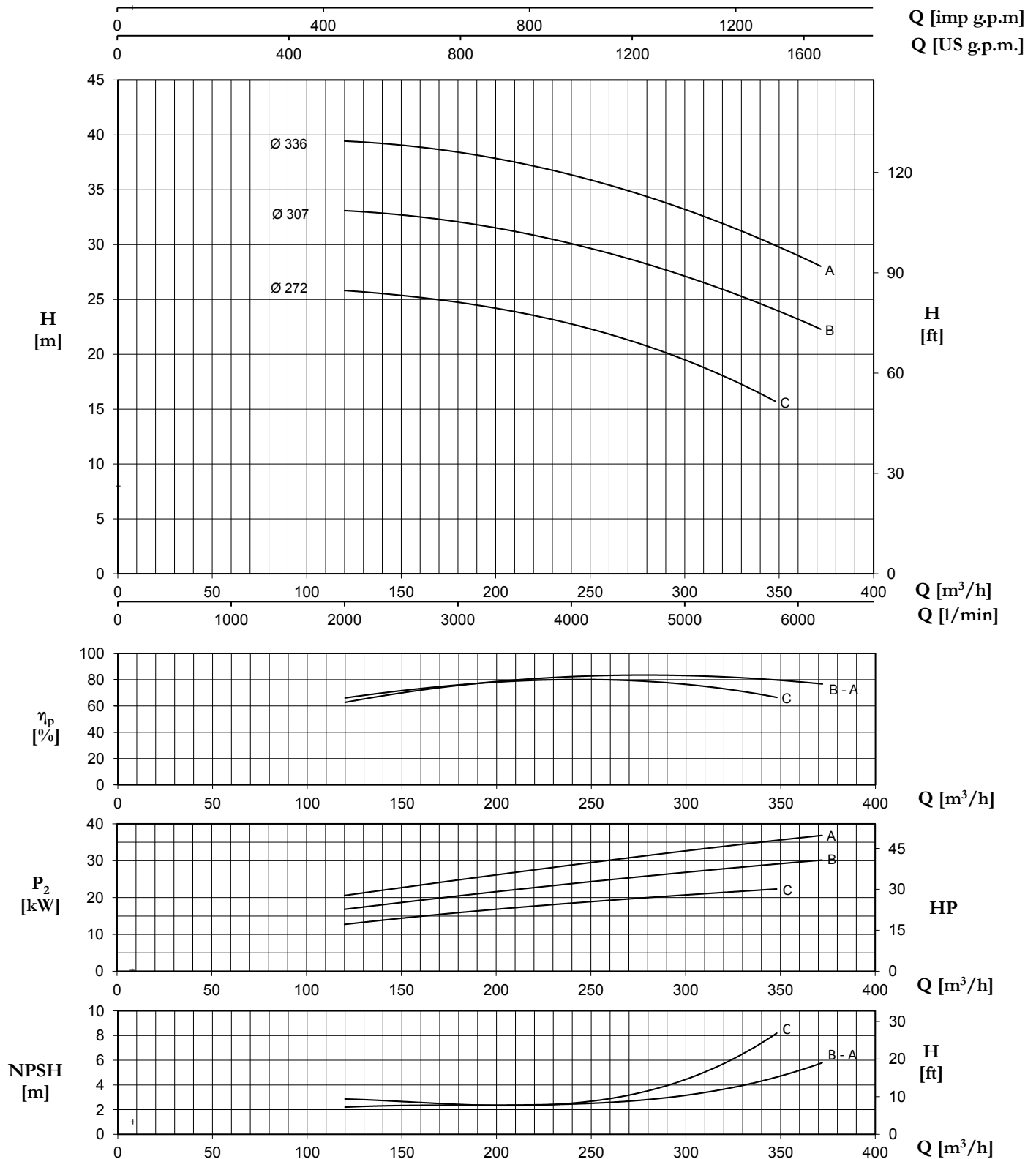

Tolerance: ISO 9906:2012 - Grade 3B

TYPE	Nominal Power (kW)	Motor Size	Q (m³/h - l/min)									
			0	120	144	156	180	204	228	252	348	372
			0	2000	2400	2600	3000	3400	3800	4200	5800	6200
H (m)												
pump input power (kW)												
125-315C	22	180L	24,1 7,23	25,8 12,72	25,5 14,05	25,3 14,70	24,7 15,95	24,1 16,99	23,3 17,98	22,2 18,99	15,7 22,32	
125-315B	30	200L	31,5 9,52	33,0 16,73	32,9 18,36	32,7 19,15	32,1 20,43	31,3 21,67	30,6 23,13	29,6 24,48	24,2 29,14	22,2 30,13
125-315A	37	225S	38,6 11,88	39,6 20,51	39,2 22,29	38,8 23,17	38,1 24,84	37,6 26,36	37,0 27,97	36,2 29,66	29,6 35,58	28,2 36,82

4MA/4MAT - 4MAX EN 733 ~ 1450 r.p.m.

125-400

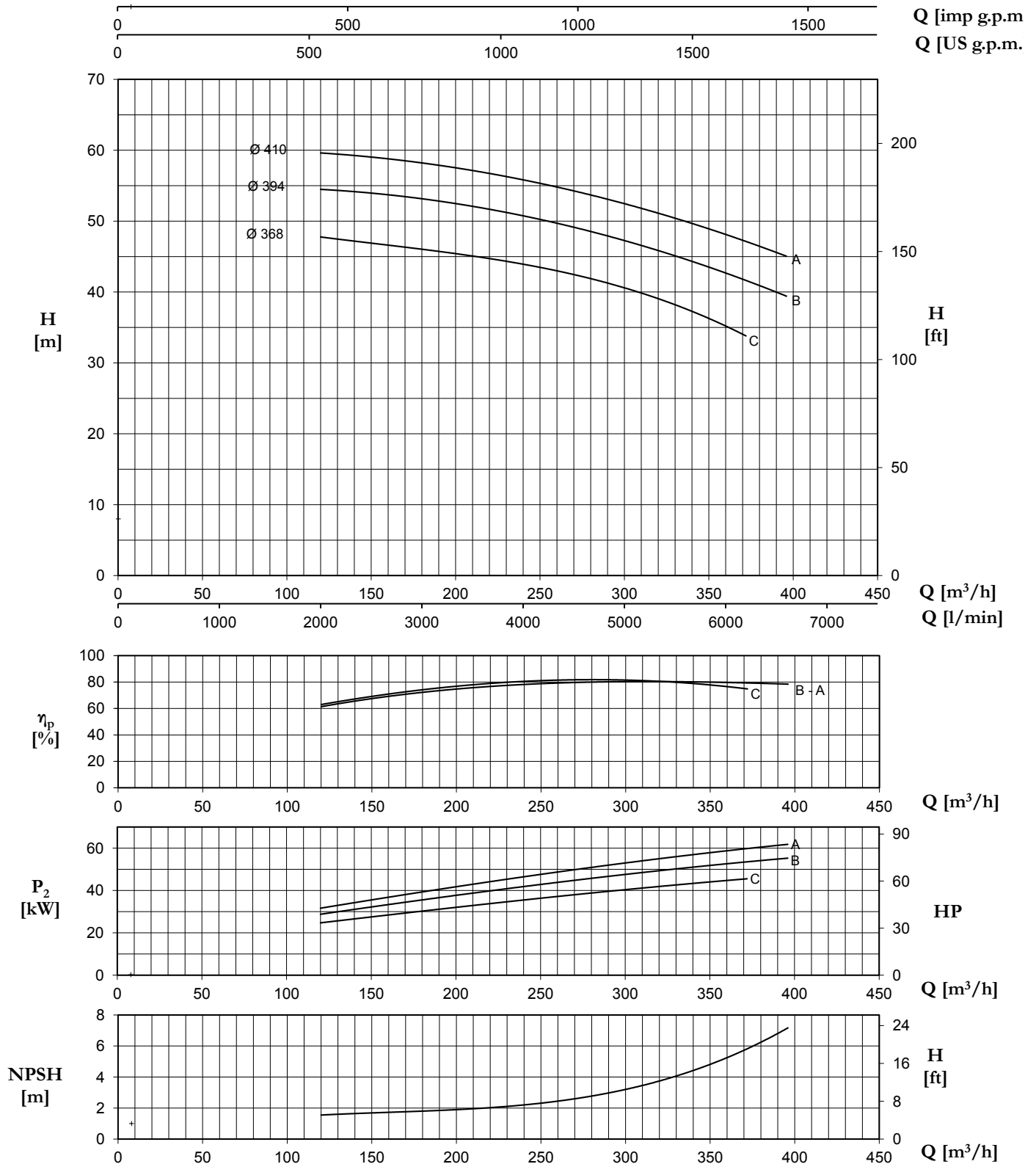

Tolerance: ISO 9906:2012 - Grade 3B

TYPE	Nominal Power (kW)	Motor Size	Q (m³/h - l/min)										
			0	120	132	150	168	192	216	240	276	372	396
			0	2000	2200	2500	2800	3200	3600	4000	4600	6200	6600
H (m) pump input power (kW)													
125-400C	45	225M	46,2 13,91	47,6 24,65	47,5 25,83	47,0 27,62	46,5 29,31	45,7 31,22	44,7 33,24	43,7 35,62	42,4 38,53	33,8 45,52	
125-400B	55	250M	53,4 16,79	54,5 28,74	54,3 30,15	54,0 32,25	53,5 34,30	52,7 36,85	51,7 39,30	50,6 41,82	48,8 45,43	42,0 53,55	39,1 55,27
125-400A	75	280S	58,6 18,95	59,5 31,66	59,4 33,20	59,1 35,52	58,7 37,81	57,8 40,77	56,8 43,66	55,7 46,50	53,9 50,49	47,2 59,76	45,0 61,83

4MA/4MAT - 4MAX EN 733 ~ 1450 r.p.m.

150-315

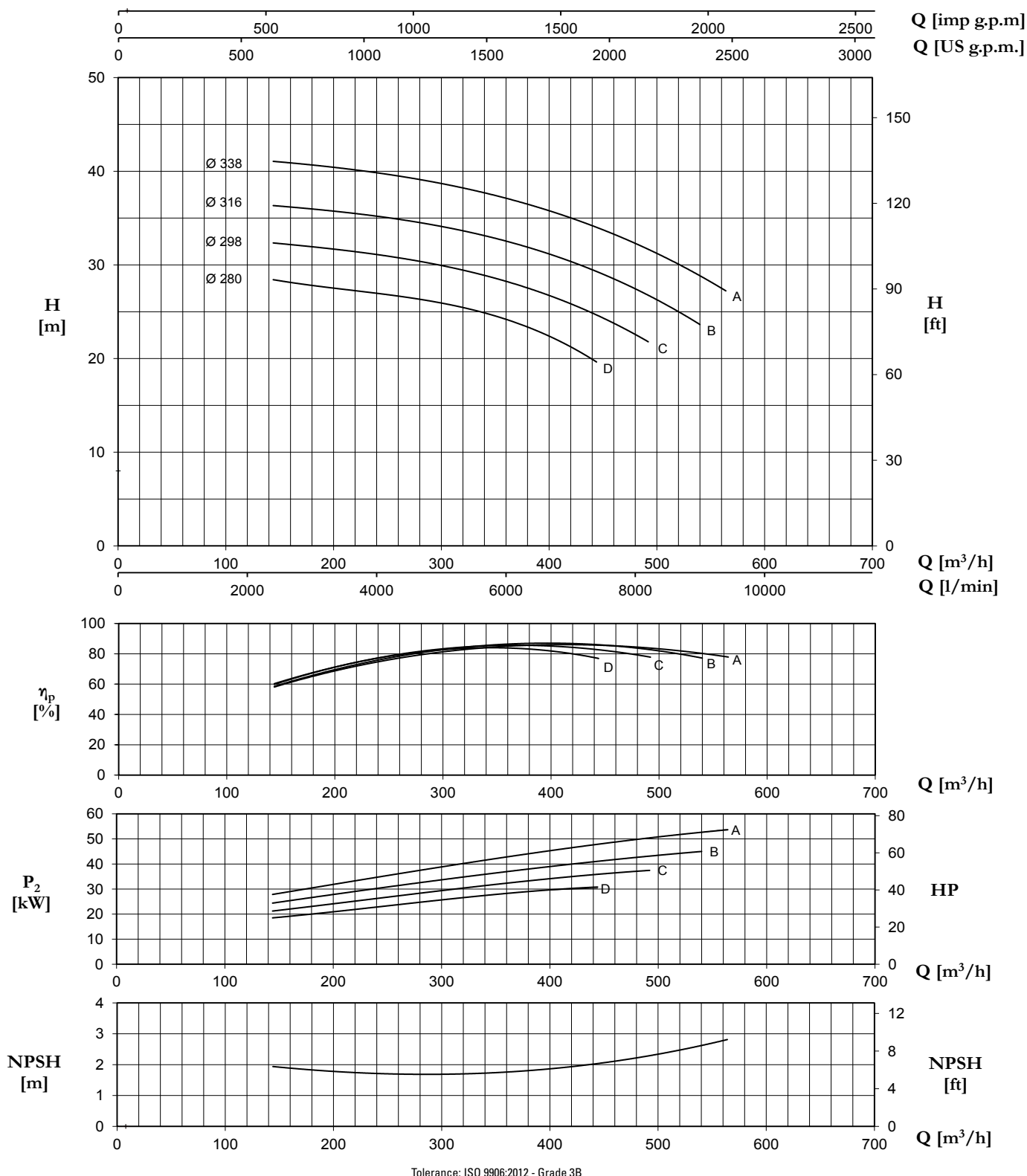

TYPE	Nominal Power (kW)	Motor Size	Q (m³/h - l/min)												
			0	144	192	228	252	348	396	444	492	540	564		
			0	2400	3200	3800	4200	5800	6600	7400	8200	9000	9400		
H (m)															
pump input power (kW)															
150-315D	30	200L	25,7	28,3	27,9	27,2	26,5	24,7	22,7	19,6					
			12,22	18,44	20,71	22,23	23,25	27,81	29,56	30,78					
150-315C	37	225S	29,6	32,2	32,1	31,3	30,7	28,6	27,0	24,7	21,8				
			14,01	21,16	23,85	25,58	26,73	31,79	34,00	35,84	37,45				
150-315B	45	225M	34,0	36,3	36,0	35,4	34,9	32,8	31,3	29,3	26,9	23,6			
			16,47	24,33	27,47	29,51	30,83	36,29	38,77	41,13	43,09	44,99			
150-315A	55	250M	39,4	41,0	40,8	40,0	39,5	37,6	35,8	34,1	31,7	28,9	27,2		
			18,39	27,78	31,31	33,92	35,59	41,75	45,02	48,12	50,36	52,60	53,65		

4MA/4MAT - 4MAX EN 733 ~ 1450 r.p.m.

150-400

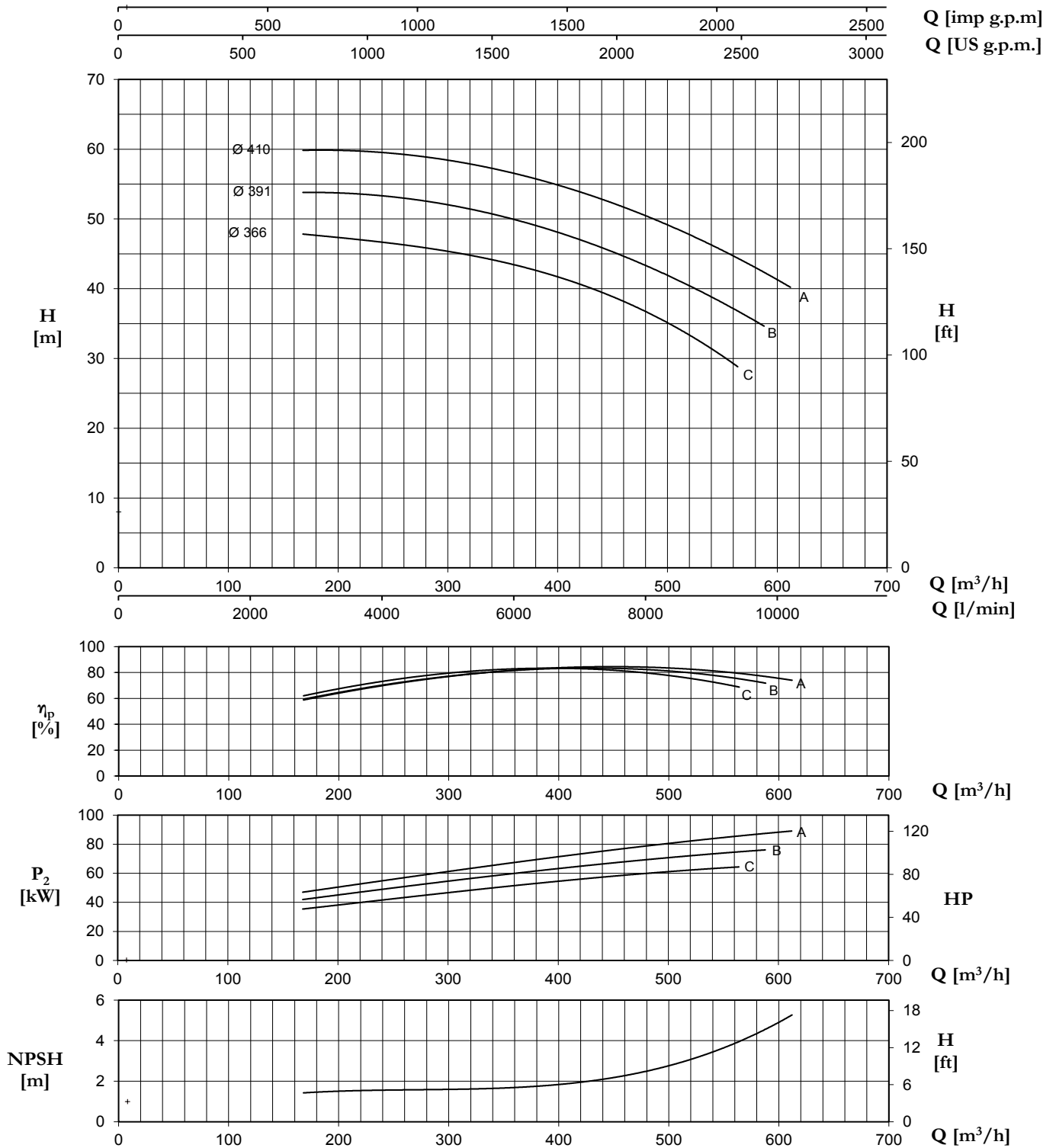

Tolerance: ISO 9906:2012 - Grade 3B

TYPE	Nominal Power (kW)	Motor Size	H (m)											
			0	168	192	216	240	276	372	444	540	564	588	612
			pump input power (kW)											
150-400C	75	280S	45,6 20,78	47,8 35,35	47,6 37,46	47,2 39,58	46,7 41,65	45,8 44,48	43,1 52,51	39,2 57,61	31,5 63,18	28,7 64,43		
150-400B	75	280S	52,8 26,57	54,4 41,90	53,9 44,29	53,5 46,65	52,9 48,96	51,8 52,35	49,8 60,86	46,1 66,80	39,1 73,30	36,7 74,72	34,3 76,14	
150-400A	90	280M	59,0 29,82	60,3 47,01	60,0 49,59	59,9 52,18	59,1 54,78	58,1 58,76	56,0 68,45	53,3 75,79	46,7 83,73	44,5 85,61	42,2 87,41	39,8 89,16

4MA/4MAT - 4MAX (No EN 733) ~ 1450 r.p.m.

200-315

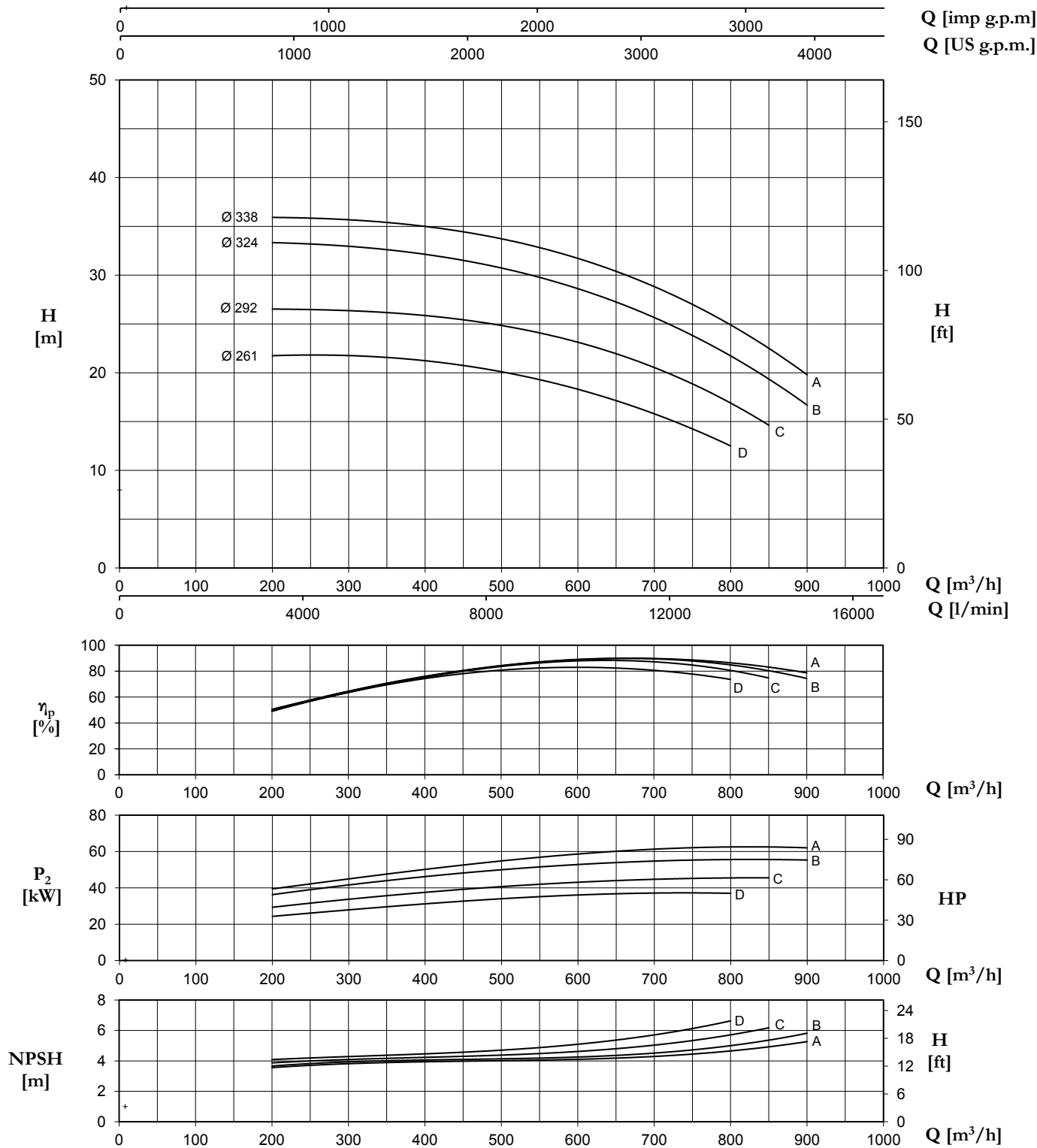

Tolerance: ISO 9906:2012 - Grade 3B

TYPE	Nominal Power (kW)	Motor Size	Q (m³/h - l/min)									
			0	200	250	400	600	800	850	900		
			0	3333	4167	5000	10000	13333	14167	15000		
H (m)												
pump input power (kW)												
200-315D	37	225S	21,2	21,7	21,8	21,2	18,3	12,5				
			18,00	24,31	26,11	31,21	36,07	37,00				
200-315C	45	225M	26,6	26,6	26,4	25,9	23,1	16,9	14,6			
			21,54	29,42	31,44	37,61	43,07	45,42	45,55			
200-315B	55	250M	33,4	33,4	33,2	32,2	28,6	21,7	19,4	16,7		
			25,04	36,30	38,91	46,32	52,72	55,67	55,62	55,25		
200-315A	75	280S	36,3	35,9	35,8	35,0	31,8	24,9	22,5	19,8		
			27,90	39,49	42,13	50,07	58,82	62,36	62,45	62,15		

4MA/4MAT - 4MAX (No EN 733) ~ 1450 r.p.m.

200-400

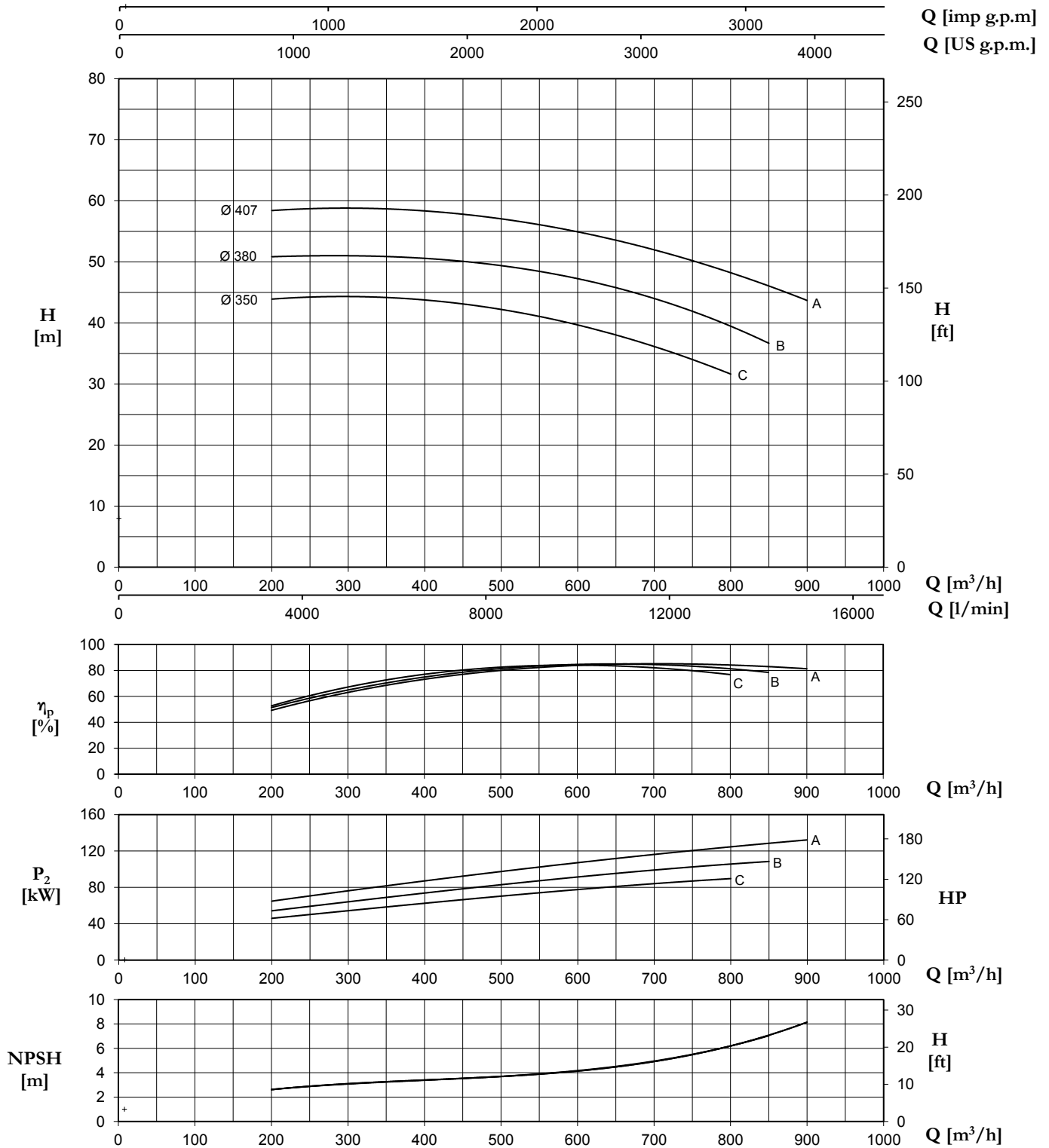

Tolerance: ISO 9906:2012 - Grade 3B

TYPE	Nominal Power (kW)	Motor Size	Q (m³/h - l/min)							
			0	200	250	400	600	800	850	900
			0	3333	4167	6667	10000	13333	14167	15000
H (m)										
pump input power (kW)										
200-400C	90	280M	43,0	44,1	44,1	43,6	39,9	31,5		
			31,27	45,90	50,14	62,49	77,58	89,60		
200-400B	110	315S	49,5	50,8	51,0	50,6	47,2	39,5	36,6	
			40,00	54,29	58,92	73,89	91,32	105,65	108,43	
200-400A	132	315M	57,2	58,5	58,6	58,2	55,2	48,2	45,6	44,0
			49,00	65,01	70,26	87,26	107,05	124,54	128,46	132,15

250-315

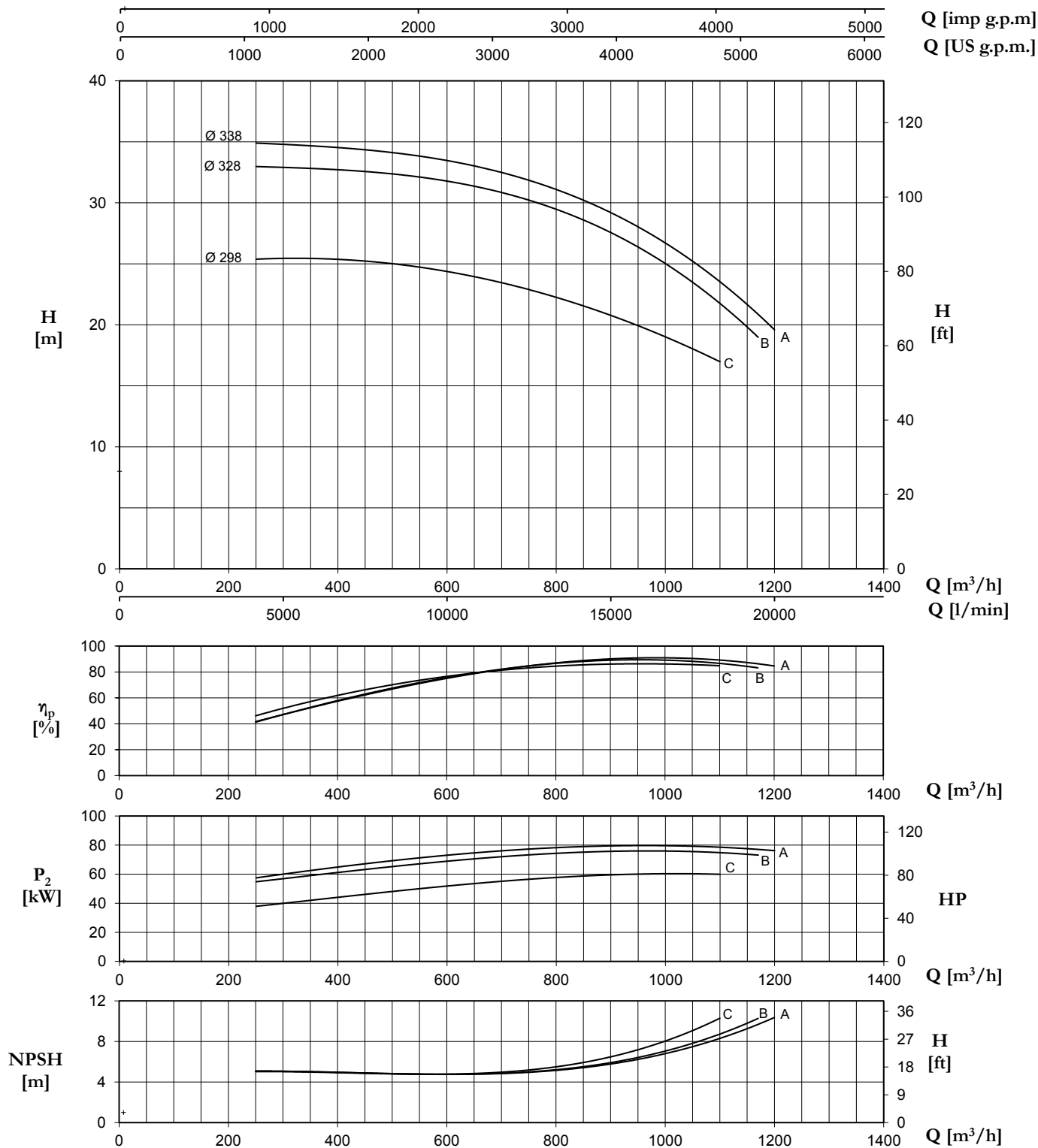

Tolerance: ISO 9906:2012 - Grade 3B

TYPE	Nominal Power (kW)	Motor Size	Q (m³/h - l/min)									
			0	250	400	600	800	850	900	1100	1170	1200
			0	4167	6667	10000	13333	14167	15000	18333	19500	20000
H (m)												
pump input power (kW)												
250-315C	55	250M	26,1	25,5	25,3	24,1	22,3	21,7	21,0	16,8		
	75	280S	28,00	37,82	44,23	51,71	57,65	58,82	59,57	59,89		
250-315B	75	280S	33,2	33,0	32,7	31,8	29,6	28,6	27,5	21,7	19,0	
			43,46	54,77	61,20	68,72	74,57	75,26	75,64	74,47	73,35	
250-315A	90	280M	35,8	35,0	34,4	33,3	31,3	30,4	29,3	23,0	20,7	20,0
			46,41	57,61	64,50	73,28	78,44	79,01	79,32	78,27	77,03	76,36

4MA/4MAT - 4MAX (No EN 733) ~ 1450 r.p.m.

250-400

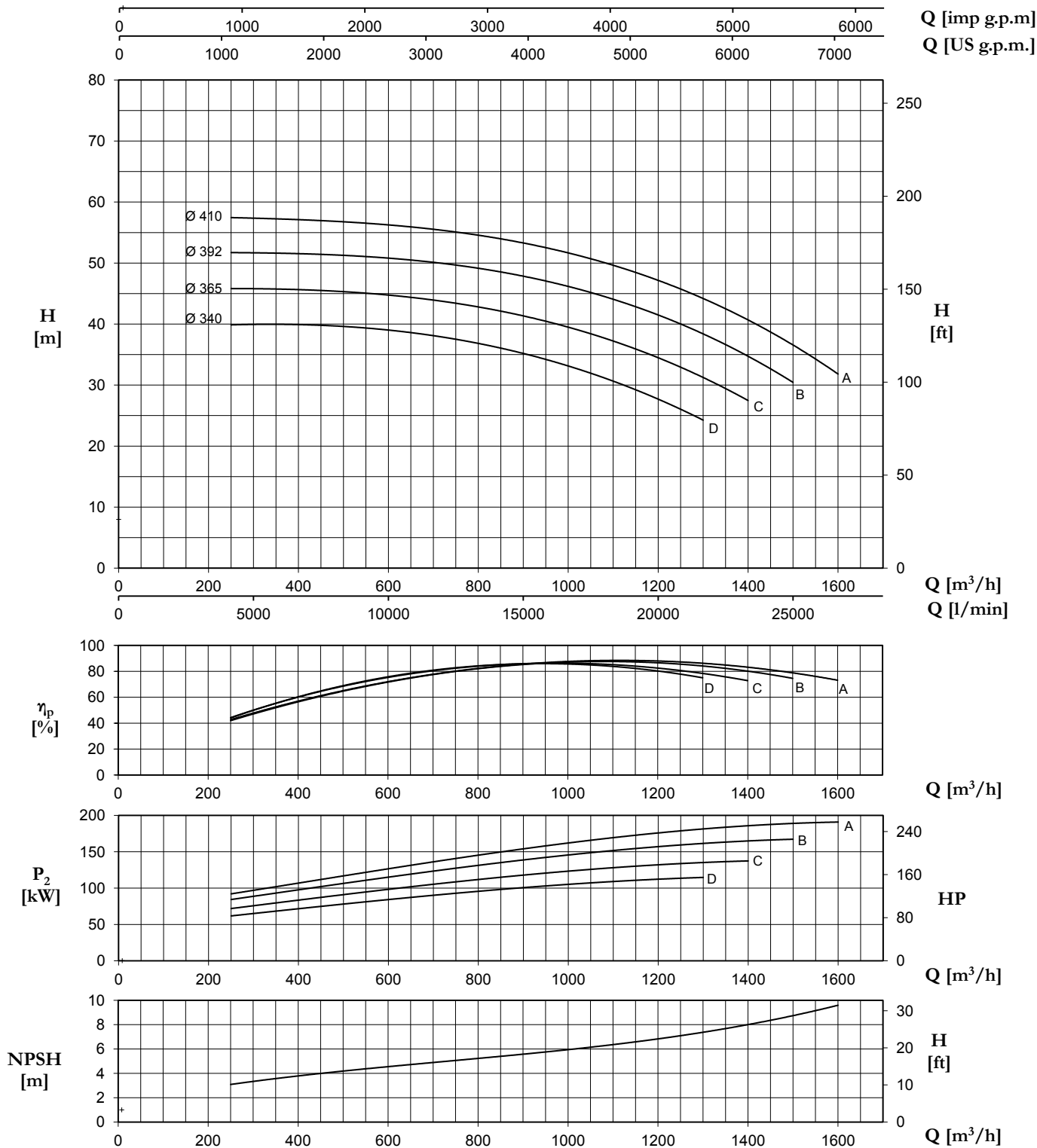

Tolerance: ISO 9906:2012 - Grade 3B

TYPE	Nominal Power (kW)	Motor Size	Q (m³/h - l/min)									
			0	250	600	900	1170	1200	1300	1400	1500	1600
			0	4167	10000	15000	19500	20000	21667	23333	25000	26667
H (m) pump input power (kW)												
250-400D	110	315S	38,3	39,9	39,0	35,2	28,6	27,7	24,3			
	132	315M	48,00	61,74	84,15	100,80	111,27	112,17	114,78			
250-400C	132	315M	44,0	45,8	44,9	41,2	35,4	34,5	31,3	27,4		
	160	315L	53,83	71,89	98,11	118,20	130,85	131,93	135,08	137,50		
250-400B	160	315L	50,0	51,7	51,0	47,6	42,3	41,5	38,5	34,8	30,3	
	200	315L	64,57	84,18	115,36	138,27	155,58	157,12	161,60	164,88	167,09	
250-400A	200	315L	55,7	57,4	56,5	53,0	47,9	47,1	44,3	40,8	36,6	31,7
			70,94	91,89	127,19	153,24	173,94	175,86	181,62	186,11	189,07	190,57

MA/MAT - MAX EN 733 ~ 2900 r.p.m.
4MA/4MAT - 4MAX EN 733 ~ 1450 r.p.m.

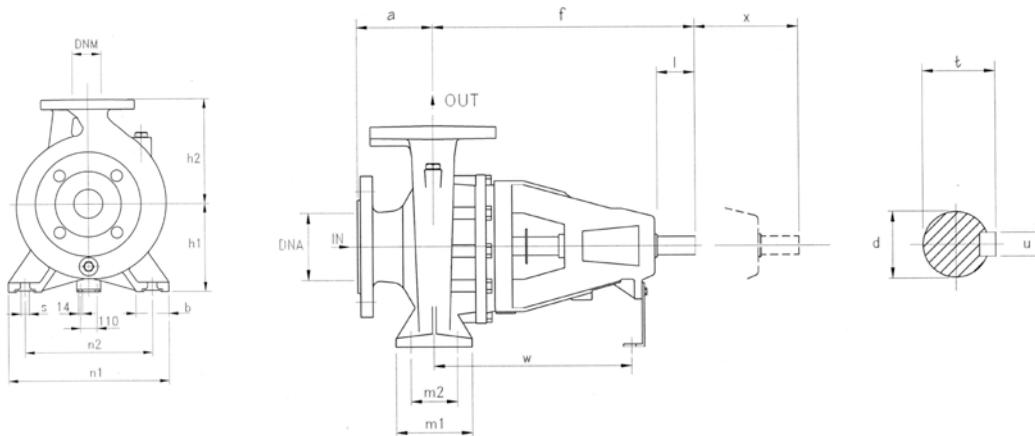

TYPE	DIMENSIONS (mm)																					Kg
	DNA	DNM	a	f	h1	h2	m1	m2	n1	n2	s	b	l	d	t	u	x	w	I	L	M	
32-160			80	360	132	160	100	70	240	190	14	50	50	24	27	8	100	260	535	320	445	38
32-200	50	32	80	360	160	180	100	70	240	190	14	50	50	24	27	8	100	260	535	320	445	41
32-250			100	360	180	225	125	95	320	250	14	65	65	24	27	8	100	260	545	405	545	49
40-125			80	360	112	140	100	70	210	160	14	50	50	24	27	8	100	260	535	320	445	37
40-160			80	360	132	160	100	70	240	190	14	50	50	24	27	8	100	260	535	320	445	40
40-200			100	360	160	180	100	70	265	212	14	50	50	24	27	8	100	260	535	320	445	44
40-250			100	360	180	225	125	95	320	250	14	65	50	24	27	8	100	260	545	405	545	49,5
50-125			100	360	132	160	100	70	240	190	14	50	50	24	27	8	100	260	535	320	445	39,5
50-160			100	360	160	180	100	70	265	212	14	50	50	24	27	8	100	260	535	320	445	44
50-200			100	360	160	200	100	70	265	212	14	50	50	24	27	8	100	260	535	320	445	47
50-250			100	360	180	225	125	95	320	250	14	65	50	24	27	8	100	260	545	405	545	53
50-315	80		125	470	225	280	125	95	345	280	14	65	80	32	35,3	10	100	340	655	465	620	94,5
65-125			100	360	160	180	125	95	280	212	14	65	65	24	27	8	100	260	535	320	445	44,5
65-160			100	360	160	200	125	95	280	212	14	65	65	24	27	8	100	260	535	320	445	49
65-200			100	360	180	225	125	95	320	250	14	65	65	24	27	8	140	260	545	405	545	54
65-250			100	470	200	250	160	120	360	280	19	80	80	32	35	10	140	340	545	405	545	76,5
65-315			125	470	225	280	160	120	400	315	19	80	80	32	35	10	140	340	655	465	620	96
80-160			125	360	180	225	125	95	320	250	14	65	50	24	27	8	140	260	545	405	545	58
80-200			125	470	180	250	125	95	345	280	14	65	80	32	35	10	140	340	680	405	545	74
80-250			125	470	200	280	160	120	400	315	18	80	80	32	35,3	10	140	340	655	465	585	91
80-315			125	470	250	315	160	120	400	315	18	80	80	32	35,3	10	140	340	655	465	620	106
100-200			125	470	200	280	160	120	360	286	18	80	80	32	35,3	10	140	340	655	465	620	95
100-250			140	470	225	280	160	120	400	315	18	80	80	32	35,3	10	140	340	655	465	620	103
100-315			140	470	250	315	160	120	400	315	18	80	80	32	35,3	10	140	340	655	465	620	122
100-400			140	530	280	355	200	150	500	400	22	100	110	42	45,3	12	140	370	720	775	855	183,5
125-250			160	530	315	450	200	150	400	315	22	100	110	32	45,3	12	140	370	655	465	620	132
125-315			140	530	280	355	200	150	500	400	22	100	110	42	45,3	12	140	370	720	775	855	176
125-400			140	530	315	400	200	150	500	400	22	100	110	42	45,3	12	140	370	720	775	855	198
150-315			160	530	280	400	200	150	550	450	22	100	110	42	45,3	12	140	370	655	465	620	191
150-400			160	530	315	450	200	150	550	450	22	100	110	42	45,3	12	140	370	720	775	855	218,5
200-315			180	706	355	450	250	190	634	500	28	134	110	55	58,3	16	208	523	800	1200	1150	345
200-400			180	706	355	500	250	190	634	500	28	134	110	55	58,3	16	214	523	800	1200	1150	346
250-315			225	711	400	500	250	200	694	560	28	134	110	55	58,3	16	214	528	800	1200	1070	401,5
250-400			225	706	400	550	250	200	694	560	28	134	110	55	58,3	16	220	523	800	1200	1120	393

DIMENSIONS (mm)				
DN	D	K	holes	
			n°	Ø
32	140	100	4	18
40	150	110	4	18
50	165	125	4	18
65	185	145	4	18
80	200	160	8	18
100	220	180	8	18
125	250	210	8	18
150	285	240	8	23
200	340	295	8	23
250	395	350	12	23
300	445	400	12	23

MA/MAT - MAX EN 733 ~ 2900 r.p.m.

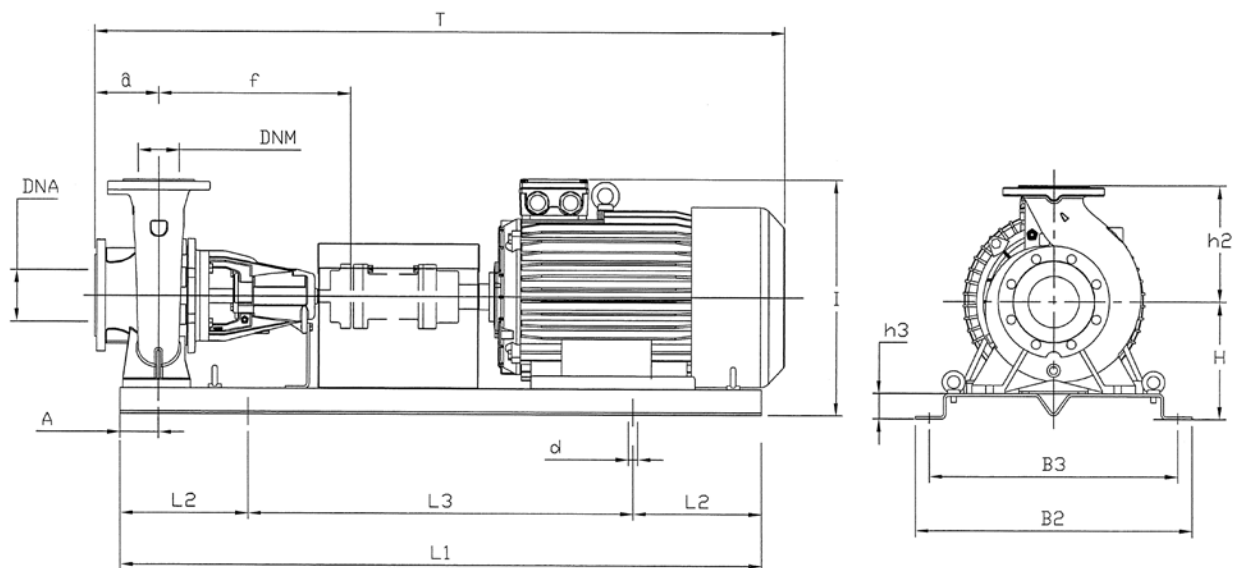

TYPE	kW	Motor Size	DIMENSIONS (mm)																Kg
			DNA	DNM	a	f	H	h2	h3	L1	L2	L3	B2	B3	A	d	T	I	
32-160C	1,5	90S	50	32	80	360	182	160	50	800	130	540	360	320	60	18	855	342	82
32-160C	2,2	90L	50	32	80	360	182	160	50	900	150	600	390	350	60	18	920	342	88
32-160B	2,2	90L	50	32	80	360	182	160	50	900	150	600	390	350	60	18	920	342	87,7
32-160A	3	100L	50	32	80	360	182	160	50	900	150	600	390	350	60	18	920	362	95,7
32-160A	4	112M	50	32	80	360	182	160	50	900	150	600	390	350	60	18	940	375	102,7
32-200C	4	112M	50	32	80	360	210	180	50	900	150	600	390	350	60	18	940	403	106,7
32-200B	5,5	132S	50	32	80	360	210	180	50	1000	170	660	450	400	60	22	1020	433	131,3
32-200A	7,5	132S	50	32	80	360	210	180	50	1000	170	660	450	400	60	22	1020	433	134,3
32-250C	11	160M	50	32	100	360	230	225	50	1250	205	840	540	490	75	22	1275	495	196,3
32-250B	11	160M	50	32	100	360	230	225	50	1250	205	840	540	490	75	22	1275	495	196,3
32-250B	15	160M	50	32	100	360	230	225	50	1250	205	840	540	490	75	22	1275	495	206,3
32-250A	15	160M	50	32	100	360	230	225	50	1250	205	840	540	490	75	22	1275	495	206,3
40-125C	1,5	90S	65	40	80	360	162	140	50	800	130	540	360	320	60	18	855	317	82,2
40-125B	2,2	90L	65	40	80	360	162	140	50	900	150	600	390	350	60	18	920	317	87,8
40-125A	3	100L	65	40	80	360	162	140	50	900	150	600	390	350	60	18	920	342	95,8
40-160B	3	100L	65	40	80	360	182	160	50	900	150	600	390	350	60	18	920	362	98,8
40-160B	4	112M	65	40	80	360	182	160	50	900	150	600	390	350	60	18	940	375	105,8
40-160A	4	112M	65	40	80	360	182	160	50	900	150	600	390	350	60	18	940	375	105,8
40-160A	5,5	132S	65	40	80	360	182	160	50	1000	170	660	450	400	60	22	1020	405	130,4
40-200B	5,5	132S	65	40	100	360	210	180	50	1000	170	660	450	400	60	22	1040	433	134,4
40-200A	7,5	132S	65	40	100	360	210	180	50	1000	170	660	450	400	60	22	1040	433	137,4
40-250C	11	160M	65	40	100	360	230	225	50	1250	205	840	540	490	75	22	1275	495	197,9
40-250B	11	160M	65	40	100	360	230	225	50	1250	205	840	540	490	75	22	1275	495	197,9
40-250B	15	160M	65	40	100	360	230	225	50	1250	205	840	540	490	75	22	1275	495	207,9
40-250A	15	160M	65	40	100	360	230	225	50	1250	205	840	540	490	75	22	1275	495	207,9
40-250A	18,5	160L	65	40	100	360	230	225	50	1250	205	840	540	490	75	22	1275	495	224,9
40-250BM	18,5	160L	65	40	100	360	230	225	50	1250	205	840	540	490	75	22	1275	495	224,9
40-250AM	22	180M	65	40	100	360	230	225	50	1250	205	840	540	490	75	22	1275	510	264,3

MA/MAT - MAX EN 733 ~ 2900 r.p.m.

TYPE	kW	Motor Size	DIMENSIONS (mm)																Kg
			DNA	DNM	a	f	H	h2	h3	L1	L2	L3	B2	B3	A	d	T	I	
50-125B	3	100L	65	50	100	360	182	160	50	900	150	600	390	350	60	18	940	362	98,7
50-125B	4	112M	65	50	100	360	182	160	50	900	150	600	390	350	60	18	960	375	105,7
50-125A	4	112M	65	50	100	360	182	160	50	900	150	600	390	350	60	18	960	375	105,7
50-125A	5,5	132S	65	50	100	360	182	160	50	1000	170	660	450	400	60	22	1040	405	130,3
50-160B	5,5	132S	65	50	100	360	210	180	50	1000	170	660	450	400	60	22	1040	433	134,8
50-160A	7,5	132S	65	50	100	360	210	180	50	1000	170	660	450	400	60	22	1040	433	137,8
50-200C	11	160M	65	50	100	360	210	200	50	1120	190	740	490	440	60	22	1168	475	190,8
50-200B	11	160M	65	50	100	360	210	200	50	1120	190	740	490	440	60	22	1168	475	190,8
50-200A	15	160M	65	50	100	360	210	200	50	1120	190	740	490	440	60	22	1168	475	200,8
50-250C	15	160M	65	50	100	360	230	225	50	1250	205	840	540	490	75	22	1275	495	211,8
50-250C	18,5	160L	65	50	100	360	230	225	50	1250	205	840	540	490	75	22	1275	495	228,8
50-250B	18,5	160L	65	50	100	360	230	225	50	1250	205	840	540	490	75	22	1275	495	228,8
50-250B	22	180M	65	50	100	360	230	225	50	1250	205	840	540	490	75	22	1275	510	268,2
50-250A	22	180M	65	50	100	360	230	225	50	1250	205	840	540	490	75	22	1275	510	268,2
50-250A	30	200L	65	50	100	360	230	225	50	1400	230	940	610	550	75	26	1425	560	326,2
50-315DN	37	200L	80	50	125	470	275	280	50	1400	230	940	610	550	75	26	1455	585	387
50-315CN	45	225M	80	50	125	470	275	280	50	1400	230	940	610	550	75	26	1500	605	452,8
50-315BN	55	250M	80	50	125	470	310	280	85	1600	270	1060	660	600	75	26	1650	710	573,8
50-315AN	75	280S	80	50	125	470	310	280	85	1800	300	1200	730	670	75	26	1850	770	726,8
65-125B	5,5	132S	80	65	100	360	210	180	50	1000	170	660	450	400	60	22	1040	433	136,6
65-125A	7,5	132S	80	65	100	360	210	180	50	1000	170	660	450	400	60	22	1040	433	136,6
65-160C	11	160M	80	65	100	360	210	200	50	1120	190	740	490	440	60	22	1168	475	194,1
65-160B	11	160M	80	65	100	360	210	200	50	1120	190	740	490	440	60	22	1168	475	194,1
65-160A	15	160M	80	65	100	360	210	200	50	1120	190	740	490	440	60	22	1168	475	204,1
65-200C	15	160M	80	65	100	360	230	225	50	1250	205	840	540	490	75	22	1275	495	214,5
65-200B	18,5	160L	80	65	100	360	230	225	50	1250	205	840	540	490	75	22	1275	495	231,5
65-200A	22	180M	80	65	100	360	230	225	50	1250	205	840	540	490	75	22	1290	510	270,3
65-250B	30	200L	80	65	100	470	250	250	50	1400	230	940	610	550	90	26	1470	560	350,8
65-250A	37	200L	80	65	100	470	250	250	50	1400	230	940	610	550	90	26	1470	560	369,8
65-315CN	55	250M	80	65	125	470	310	280	85	1600	270	1060	660	600	90	26	1645	710	576,2
65-315BN	75	280S	80	65	125	470	310	280	85	1800	300	1200	730	670	90	26	1835	770	729,2
65-315AN	90	280M	80	65	125	470	310	280	85	1800	300	1200	730	670	90	26	1835	770	759,2
80-160E	11	160M	100	80	125	360	230	225	50	1250	205	840	540	490	75	22	1300	495	209,8
80-160D	11	160M	100	80	125	360	230	225	50	1250	205	840	540	490	75	22	1300	495	209,8
80-160C	15	160M	100	80	125	360	230	225	50	1250	205	840	540	490	75	22	1300	495	219,8
80-160B	18,5	160L	100	80	125	360	230	225	50	1250	205	840	540	490	75	22	1300	495	236,8
80-160A	22	180M	100	80	125	360	230	225	50	1250	205	840	540	490	75	22	1315	510	275,7
80-200B	30	200L	100	80	125	470	230	250	50	1400	230	940	610	550	75	26	1495	560	349,7
80-200A	37	200L	100	80	125	470	230	250	50	1400	230	940	610	550	75	26	1495	560	368,7
80-250B	45	225M	100	80	125	470	250	280	50	1400	230	940	610	550	90	26	1540	605	451,5
80-250A	55	250M	100	80	125	470	285	280	85	1600	270	1060	660	600	90	26	1645	710	572,5
80-315BN	90	280M	100	80	125	470	335	315	85	1800	300	1200	730	670	90	26	1835	770	770,5
80-315AN	110	315M	100	80	125	470	-	315	-	-	-	-	-	-	90	-	-	-	-
100-200B	45	225M	125	100	125	470	250	280	50	1400	230	940	610	550	90	26	1540	605	458,5
100-200A	55	250M	125	100	125	470	285	280	85	1600	270	1060	660	600	90	26	1645	710	579,5
100-250C	55	250M	125	100	140	470	310	280	85	1600	270	1060	660	600	90	26	1660	710	587,5
100-250C	75	280S	125	100	140	470	310	280	85	1800	300	1200	730	670	90	26	1850	770	740,5
100-250B	75	280S	125	100	140	470	310	280	85	1800	300	1200	730	670	90	26	1850	770	740,5
100-250A	90	280M	125	100	140	470	310	280	85	1800	300	1200	730	670	90	26	1850	770	770,5

4MA/4MAT - 4MAX EN 733 ~ 1450 r.p.m.

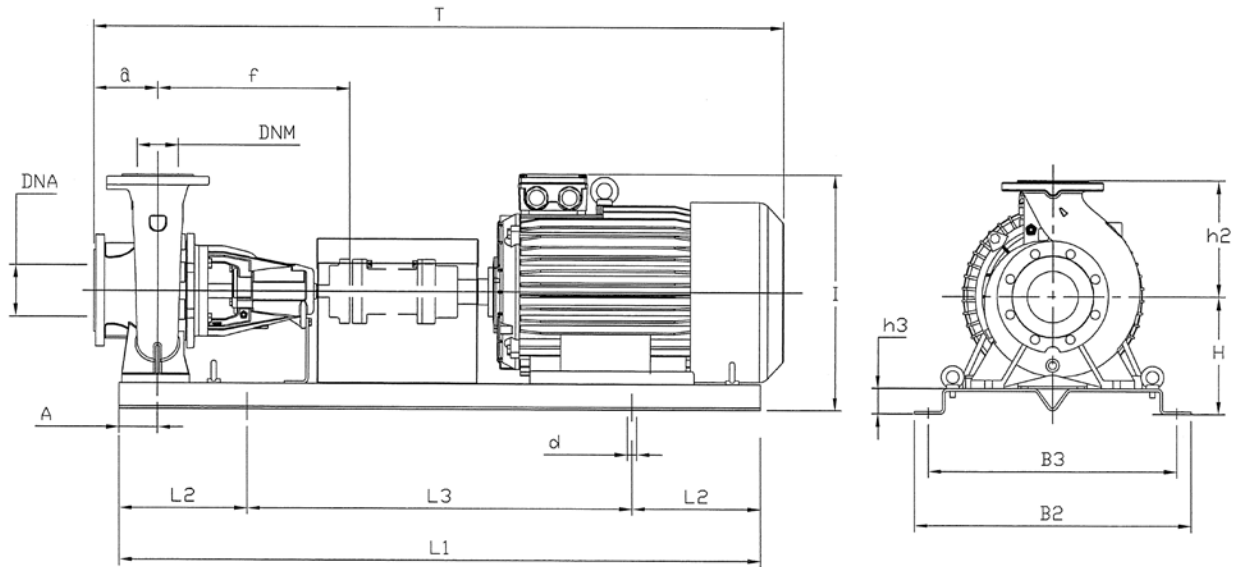

TYPE	kW	Motor Size	DIMENSIONS (mm)																	Kg
			DNA	DNM	a	f	H	h2	h3	L1	L2	L3	B2	B3	A	d	T	I		
32-160C	0,37	71M	50	32	80	360	182	160	50	800	130	540	360	320	60	18	820	342	78	
32-160B	0,37	71M	50	32	80	360	182	160	50	800	130	540	360	320	60	18	820	342	78	
32-160A	0,55	80M	50	32	80	360	182	160	50	800	130	540	360	320	60	18	820	342	78,1	
32-200C	0,75	80M	50	32	80	360	210	180	50	800	130	540	360	320	60	18	820	390	82,1	
32-200B	1,1	90S	50	32	80	360	210	180	50	800	130	540	360	320	60	18	855	390	86,1	
32-200A	1,1	90S	50	32	80	360	210	180	50	800	130	540	360	320	60	18	855	390	86,1	
32-250C	1,5	90S	50	32	100	360	230	225	50	1000	170	660	450	400	75	22	1025	455	105,7	
32-250B	1,5	90S	50	32	100	360	230	225	50	1000	170	660	450	400	75	22	1025	455	105,7	
32-250A	2,2	100L	50	32	100	360	230	225	50	1000	170	660	450	400	75	22	1025	455	111,7	
40-125C	0,37	71M	65	40	80	360	162	140	50	800	130	540	360	320	60	18	820	302	78,5	
40-125B	0,37	71M	65	40	80	360	162	140	50	800	130	540	360	320	60	18	820	302	78,5	
40-125A	0,55	80M	65	40	80	360	162	140	50	800	130	540	360	320	60	18	820	307	78,2	
40-160B	0,55	80M	65	40	80	360	182	160	50	800	130	540	360	320	60	18	820	342	81,2	
40-160A	0,75	80M	65	40	80	360	182	160	50	800	130	540	360	320	60	18	820	342	81,2	
40-200B	1,1	90S	65	40	100	360	210	180	50	900	150	600	390	350	60	18	940	390	91,8	
40-200A	1,1	90S	65	40	100	360	210	180	50	900	150	600	390	350	60	18	940	390	91,8	
40-200A	1,5	90S	65	40	100	360	210	180	50	900	150	600	390	350	60	18	940	390	97,8	
40-250C	1,1	90S	65	40	100	360	230	225	50	1000	170	660	450	400	75	22	1025	455	101,3	
40-250C	1,5	90S	65	40	100	360	230	225	50	1000	170	660	450	400	75	22	1025	455	107,3	
40-250B	2,2	100L	65	40	100	360	230	225	50	1000	170	660	450	400	75	22	1025	455	113,3	
40-250A	2,2	100L	65	40	100	360	230	225	50	1000	170	660	450	400	75	22	1025	455	113,3	
40-250A	3	100L	65	40	100	360	230	225	50	1000	170	660	450	400	75	22	1025	455	117,3	

